



LIFESTYLE  
**WD**

---

CATALOG  
**2025**

---



**IT** Una linea di utensili ed oggetti per la casa, la cucina ed il tempo libero, concepita in maniera innovativa e cosmopolita, con occhio sempre attento ai nuovi trend in termini di design e materiali.

Lo stile giovane, colorato e contemporaneo rimane saldo e presente all'interno di questo catalogo. Per la realizzazione dei nostri prodotti utilizziamo, dove possibile, materiali riciclati; i fornitori dei nostri packaging sono da noi sempre più sensibilizzati all'utilizzo di carta e cartone certificati FSC, ovvero provenienti da foreste gestite in maniera corretta e responsabile secondo rigorosi standard ambientali, sociali ed economici.

**EN** A line of items and kitchen objects that has been developed in a very innovative and cosmopolitan way, with an eye towards new trends in terms of design and materials.

The young, colorful and contemporary style remains firm and present in this catalogue. For the realization of our products, where possible, we use recycled materials; our packaging suppliers are increasingly sensitized to the use of FSC-certified paper and cardboard, namely coming from forests managed in a correct and responsible manner according to strict environmental, social and economic standards.

**FR** Une ligne d'ustensiles et d'objets pour la maison, la cuisine et les loisirs, conçue de manière innovante et cosmopolite, avec un oeil toujours attentif aux nouvelles tendances en termes de design et de matériaux.

Le style jeune, coloré et contemporain reste solide et présent dans ce catalogue. Pour la réalisation de nos produits, nous utilisons, dans la mesure du possible, des matériaux recyclés; ensuite, nous encourageons de plus en plus nos fournisseurs d'emballages à utiliser du papier et de carton certifiés FSC, ou provenant de forêts gérées de manière correcte et responsable selon des normes environnementales, sociales et économiques strictes.

Uno speciale ringraziamento per la location a/Special thanks for the location to:

**Nif: alpine taste, Martinelli ceramiche, Ristorante Pizzeria al Faro, Locanda del Gatto Gordo, Lido di San Cristoforo, Lido Buena Onda e Studio Mauser**



@nif\_alpinetaste



@martinelliceramichesrl



@ristorante\_pizzeria\_al\_faro



@lidosancristoforo\_



@lidobuenaonda



@locandadelgattogordo



@studiomauser

## BREST LINE

WD803 *New*

**IT Caraffa in latta smaltata.** Leggera e resistente con motivo originale e dal gusto retrò è perfetta per apparecchiare la tua tavola anche all'aperto. Capacità: 2,6 L.

**EN Enamel tin pitcher.** Lightweight and durable with a unique, retro-style pattern, it's perfect for setting your table even outdoors. Capacity: 2.6 L.

**FR Carafe en tôle émaillée.** Légère et résistante, avec un motif original et un style rétro, elle est parfaite pour dresser votre table même en extérieur. Contenance : 2,6 L.



WD803AZ



8 053300 579853



WD803CR



8 053300 579860

15 cm



26 cm



Si lavastoviglie  
Dishwasher safe  
Lave-vaisselle possible



No microonde  
No microwave  
Pas de micro-ondes



## WD804 *New*

**IT Tazza in latta smaltata.** Con motivo originale e dal gusto retrò è perfetta per godersi una bevanda sia calda che fredda in compagnia di chi vuoi. Leggera e resistente è adatta anche per essere portata in spiaggia o in campeggio. Capacità: 350 ml.

**EN Enamel tin mugs.** Featuring an original pattern and retro style, these mugs are perfect for enjoying a hot or cold drink with anyone you choose. Lightweight and durable, they are also great for taking to the beach or camping. Capacity: 350 ml.

**FR Tasses en tôle émaillée.** Avec un motif original et un style rétro, elles sont parfaites pour savourer une boisson, chaude ou froide en compagnie. Légères et résistantes, elles sont également idéales pour être emportées à la plage ou en camping. Contenance : 350 ml.



- Ø 8 cm
- 8 cm
- Sì lavastoviglie  
Dishwasher safe  
Lave-vaisselle possible
  - No microonde  
No microwave  
Pas de micro-ondes

## WD805 *New*

**IT Set 4 tazzine da caffè in latta smaltata.** Con motivo originale e dal gusto retrò sono perfette per godersi una bevanda sia calda che fredda in compagnia di chi vuoi. Leggere e resistenti sono adatte anche per essere portate in spiaggia o in campeggio. Capacità: 150 ml.

**EN Set of 4 enamel tin coffee cups.** Featuring a unique, retro design, these cups are perfect for enjoying both hot and cold beverages with friends. Lightweight and durable, they're also suitable for taking to the beach or camping. Capacity: 150 ml.

**FR Set de 4 tasses à café en tôle émaillée.** Avec un motif original et un style rétro, ces tasses sont parfaites pour savourer une boisson chaude ou froide en bonne compagnie. Légères et résistantes, elles sont également idéales pour être emportées à la plage ou en camping. Contenance : 150 ml.



- Ø 6 cm
- 6 cm
- Sì lavastoviglie  
Dishwasher safe  
Lave-vaisselle possible
  - No microonde  
No microwave  
Pas de micro-ondes



## WD806 *New*

**IT Ciotola in latta smaltata.** Con motivo originale e dal gusto retrò è perfetta per apparecchiare la tua tavola anche all'aperto. Leggera e resistente è adatta anche per essere portata in spiaggia o in campeggio. Capacità: 400 ml.

**EN Enamel tin bowl.** With an original pattern and retro style, this set is perfect for setting your table even outdoors. Lightweight and durable, it is also ideal for taking to the beach or camping. Capacity: 400 ml.

**FR Coupelle en tôle émaillée.** Avec un motif original et un style rétro, ce set est parfait pour dresser votre table, même en plein air. Léger et résistant, il est également idéal pour être emporté à la plage ou en camping. Contenance : 400 ml.

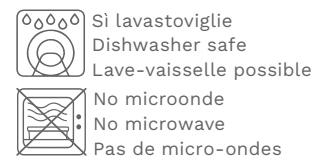
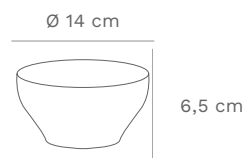

## WD807 *New*

**IT Insalatiera in latta smaltata.** Con motivo originale e dal gusto retrò è perfetta per apparecchiare la tua tavola anche all'aperto. Leggera e resistente è adatta anche per essere portata in spiaggia o in campeggio. Capacità: 2 L.

**EN Enamel tin salad bowl.** With an original pattern and retro style, this salad bowl is perfect for setting your table even outdoors. Lightweight and durable, it is also suitable for taking to the beach or camping. Capacity: 2 L.

**FR Saladier en tôle émaillée.** Avec un motif original et un style rétro, ce saladier est parfait pour dresser votre table en plein air. Léger et résistant, il est également adapté pour être emporté à la plage ou en camping. Contenance : 2 L.

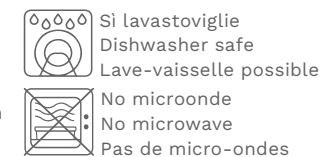

## WD808 *New*

**IT Piatto piano in latta smaltata.** Con motivo originale e dal gusto retrò è perfetta per apparecchiare la tua tavola anche all'aperto. Leggera e resistente è adatta anche per essere portata in spiaggia o in campeggio.

**EN Enamel tin dinner plate.** With an original pattern and a retro style, this plate is perfect for setting your table even outdoors. Lightweight and durable, it is also suitable for taking to the beach or camping.

**FR Assiette plate en tôle émaillée.** Avec un motif original et un style rétro, cette assiette est parfaite pour dresser votre table à l'extérieur. Légère et résistante, elle est également adaptée pour être emportée à la plage ou en camping.



WD808ARA



WD808GRA



WD808POL



WD808STE



Ø 25,5 cm



Si lavastoviglie  
Dishwasher safe  
Lave-vaisselle possible



No microonde  
No microwave  
Pas de micro-ondes



## WD809 *New*

**IT Vassoio e svuota tasche in latta smaltata.** Leggeri e resistenti con motivo originale e dal gusto retrò sono perfetti sia come articolo decorativo che per apparecchiare la tua tavola anche all'aperto.

**EN Enamel tin tray and pocket emptier.** Lightweight and durable with an original design and retro flair, they are perfect both as a decorative item and for setting your table even outdoors.

**FR Plateau et vide-poche en tôle émaillée.** Légers et résistants avec un motif original et un style rétro, ils sont parfaits tant comme article décoratif que pour dresser votre table, même en extérieur.





WD809CAV  
8 055035 680040

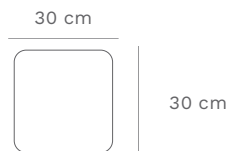

WD809POL  
8 055035 680057



-  Si lavastoviglie  
Dishwasher safe  
Lave-vaisselle possible
-  No microonde  
No microwave  
Pas de micro-ondes

## WD810, WD811 *New*

**IT Vassoi in latta smaltata.** Leggeri e resistenti con motivo originale e dal gusto retrò sono perfetti per apparecchiare la tua tavola anche all'aperto.

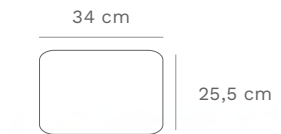

**EN Enamel tin trays.** Lightweight and durable with an original and retro design, these trays are perfect for setting your table even outdoors.

**FR Plateaux en tôle émaillée.** Légers et résistants avec un motif original et un style rétro, ces plateaux sont parfaits pour dresser votre table à l'extérieur.

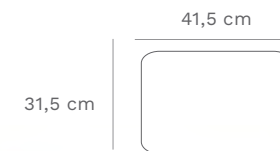

WD810ARA  
8 055035 680064



-  Si lavastoviglie  
Dishwasher safe  
Lave-vaisselle possible
-  No microonde  
No microwave  
Pas de micro-ondes

WD811STE  
8 055035 680071

# GUATAPÈ LINE

## WD796 *New*

**IT** Borsa a nodo lavorata a maglia. Colorata ed originale, ti permette di completare ogni outfit rendendolo unico. Materiale: poliestere.

**EN** Knitted knot bag. Colorful and unique, this bag allows you to complete any outfit, making it stand out. Material: polyester.

**FR** Sac à nœud tricoté. Coloré et original, ce sac vous permet de compléter n'importe quelle tenue en la rendant unique. Matériau : polyester



WD796FIO



8 053300 579723



WD796NUV



8 053300 579716



WD796OBL



8 053300 579730



WD796ORI



8 053300 579747

30 cm

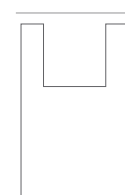

49 cm



Lavare a mano  
Hand wash  
Lavage à la main

## WD795 *New*

**IT Portacellulare lavorato a maglia.** Dotato di comoda tracolla, sarà l'accessorio indispensabile per le tue serate estive. Grazie ai suoi pattern e colori originali, completerà il tuo outfit rendendolo unico. Materiale: poliestere.

**EN Knitted phone holder.** Equipped with a convenient shoulder strap, this accessory is a must-have for your summer evenings. With its original patterns and colors, it will complete your outfit, making it unique. Material: polyester

**FR Porte-téléphone tricoté.** Muni d'une bandoulière pratique, cet accessoire sera indispensable pour vos soirées estivales. Grâce à ses motifs et couleurs originaux, il complétera votre tenue en la rendant unique. Matériau : polyester.



WD795CUO



8 053300 579679



WD795FIO



8 053300 579662



WD795NUV



8 053300 579655



WD795OBL



8 053300 579709



WD795ORI



8 053300 579693



WD795SCA



8 053300 579686

12 cm

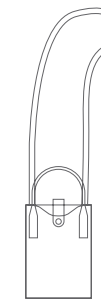

55 cm

17 cm



Lavare a mano  
Hand wash  
Lavage à la main



## WD797 *New*

**IT Borsa tote lavorata a maglia.** Capiente e colorata, ti permette di completare ogni outfit rendendolo unico ed originale. Materiale: poliestere.

**EN Knitted tote bag.** Spacious and colorful, this bag allows you to complete any outfit, making it unique and original. Material: polyester.

**FR Sac tote tricoté.** Grand et coloré, ce sac vous permet de compléter n'importe quelle tenue en la rendant unique et originale. Matériau : polyester.



## WD802 *New*

**IT Ventaglio con laccio a tracolla.** Comodo e pratico durante le calde giornate estive, dai colori e i pattern originali renderà ogni outfit originale. Inclusa nella confezione linguetta per cellulare.

**EN Folding fan with a shoulder strap.** Comfortable and practical during hot summer days, its colors and original patterns will make every outfit stand out. Cell phone tab included in the package.

**FR Éventail avec une bandoulière.** Confortable et pratique durant les chaudes journées d'été, ses couleurs et motifs originaux rendront chaque tenue unique. Onglet pour téléphone portable inclus dans le paquet.



# SINTRA LINE

## WD791 *New*

**IT** Mug in stoneware. Dona colore e allegria alla tua tavola rendendo la colazione ancora più piacevole. Capacità: 400 ml.

**EN** Stoneware mug. Brings color and joy to your table, making breakfast even more enjoyable. Capacity: 400 ml.

**FR** Mug en grès. Ajoute de la couleur et de la gaieté à ta table, rendant le petit-déjeuner encore plus agréable. Contenance : 400 ml.



WD791AR  
8 053300 579594



WD791GI  
8 053300 579570





WD791RO  
8 053300 579563



WD791V  
8 053300 579587



- 
 Sì lavastoviglie  
 Dishwasher safe  
 Lave-vaisselle possible
- 
 Sì microonde  
 Microwave safe  
 Micro-ondes possible

## WD790 *New*

**IT Tazza colazione in stoneware.** Dona colore e allegria alla tua tavola rendendo la colazione ancora più piacevole. Capacità: 400 ml.

**EN Stoneware breakfast cup.** Adds color and cheer to your table, making breakfast even more enjoyable. Capacity: 400 ml.

**FR Tasse pour le petit-déjeuner en grès.** Apporte couleur et gaieté à ta table, rendant le petit-déjeuner encore plus agréable. Contenance : 400 ml.



WD790GI



8 053300 579556



WD790N



8 053300 579532



WD790RO



8 053300 579525



WD790V



8 053300 579549



Ø 10 cm

8 cm



Si lavastoviglie  
Dishwasher safe  
Lave-vaisselle possible



Si microonde  
Microwave safe  
Micro-ondes possible



## WD792 *New*

**IT Brocca in stoneware.** Dona colore e allegria alla tua tavola rendendola unica ed originale. Capacità: 1,3 L.

**EN Stoneware pitcher.** Adds color and cheerfulness to your table, making it unique and original. Capacity: 1.3 L.

**FR Carafe en grès.** Ajoute de la couleur et de la gaieté à ta table, la rendant unique et originale. Contenance : 1,3 L.

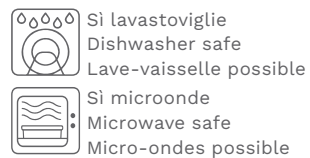

## WD793 *New*

**IT Set 4 tazzine da caffè in stoneware.** Dona colore e allegria alla tua tavola rendendola unica ed originale. Capacità: 200 ml.

**EN Set of 4 stoneware coffee cups.** Brings color and cheer to your table, making it unique and original. Capacity: 200 ml.

**FR Set de 4 tasses à café en grès.** Apporte couleur et gaieté à ta table, la rendant unique et originale. Contenance : 200 ml.

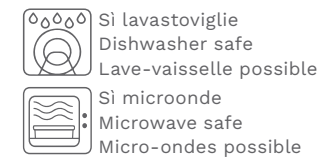
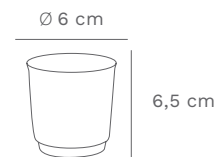

# SAMARCANDA LINE



## WD780 *New*

**IT Set 2 calici Champagne in vetro.** Dal design trendy che porterà un tocco di stile alle tue serate con gli amici. Capacità: 280ml.

**EN Set of 2 glass champagne glasses.** These champagne glasses feature a trendy design that will bring a stylish touch to your evenings with friends. Capacity: 280ml.

**FR Set de 2 flûtes à champagne en verre.** Ces flûtes à champagne, au design moderne, ajouteront une touche d'élégance à vos soirées entre amis. Contenance : 280ml.



WD780BL



8 053300 579150

WD780V



8 053300 579167

Ø 11 cm



15 cm



## WD781 *New*

**IT Set 2 calici vino in vetro.** Dal design trendy che porterà un tocco di stile alle tue serate con gli amici. Capacità: 380ml.

**EN Set of 2 glass wine glasses.** These wine glasses feature a trendy design that will bring a stylish touch to your evenings with friends. Capacity: 380ml.

**FR Set de 2 verres à vin en verre.** Ces verres à vin, au design moderne, ajouteront une touche d'élégance à vos soirées entre amis. Contenance : 380ml.



WD781BL



8 053300 579174

WD781V



8 053300 579181



Ø 8 cm



21,5 cm



No lavastoviglie  
No dishwasher  
Pas de lave-vaisselle



No microonde  
No microwave  
Pas de micro-ondes

## WD782 *New*

**IT Set 2 bicchieri acqua in vetro.** Dal design trendy e originale, aggiungi un tocco di raffinatezza ai tuoi momenti conviviali con questo bicchiere originale. Capacità: 360ml.

**EN Set of 2 glass water glasses.** These original and trendy water glasses add a touch of sophistication to your social gatherings. Capacity: 360ml.

**FR Set de 2 verres à eau en verre.** Ces verres à eau au design original et tendance apportent une touche de raffinement à vos moments de convivialité. Contenance : 360ml.



WD782B



8 053300 579198

WD782BL



8 053300 579204



Ø 9 cm



10 cm



No lavastoviglie  
No dishwasher  
Pas de lave-vaisselle



No microonde  
No microwave  
Pas de micro-ondes

WD782V



8 053300 579211

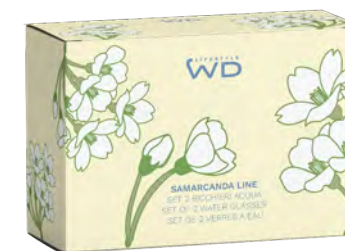

### WD783 *New*

**IT Brocca in vetro.** Dal design trendy e originale, aggiungi un tocco di raffinatezza ai tuoi momenti conviviali con questa brocca originale. Capacità: 1,5L.

**EN Glass pitcher.** This original and trendy pitcher adds a touch of refinement to your social gatherings. Capacity: 1.5L.

**FR Carafe en verre.** Avec son design original et tendance, cette carafe ajoute une touche de raffinement à vos moments de convivialité. Contenance : 1,5 L.



WD783V



WD783BL



Ø 11 cm



20,5 cm

-  No lavastoviglie  
No dishwasher  
Pas de lave-vaisselle
-  No microonde  
No microwave  
Pas de micro-ondes



## WD820 *New*

**IT Set 4 bicchieri in vetro.** Dalla forma moderna e dai colori brillanti donano colore ed originalità alla tua tavola.  
Capacità: 200 ml.

**EN Set of 4 glass tumblers.** Their modern shape and bright colors add color and originality to your table. Capacity: 200 ml.

**FR Set de 4 gobelets en verre.** Leur forme moderne et leurs couleurs vives apportent couleur et originalité à votre table. Contenance : 200 ml.



Ø 8,5 cm



10 cm

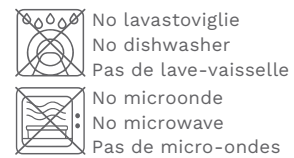

## WD722

**IT Set 2 calici da cocktail in vetro.** Dalla forma moderna e dai colori brillanti donano colore alla tua tavola e rendono i tuoi drink ancora più invitanti. Capacità: 450 ml.

**EN Set of 2 glass cocktail glasses.** With a modern shape and bright colors, they add color to your table and make your drinks even more inviting. Capacity: 450 ml.

**FR Set de 2 verres à cocktail en verre.** Avec une forme moderne et des couleurs vives, ils ajoutent de la couleur à votre table et rendent vos boissons encore plus invitantes. Contenance: 450 ml.



WD722A



8 053300 576289



WD722B



8 053300 576296



WD722C

*New*



8 053300 579020



WD722D

*New*



8 053300 579037

Ø 8,5 cm



19,5 cm



No lavastoviglie  
No dishwasher  
Pas de lave-vaisselle



No microonde  
No microwave  
Pas de micro-ondes



### WD718

**IT** Lanterna in vetro con finiture in metallo. Adatta ad ambienti classici e moderni, ideale per decorare la tua casa donando luce e calore. Candela non inclusa.

**EN** Glass lantern with metal finishes. Suitable for both classic and modern environments, ideal for decorating your home by providing light and warmth. Candle not included.

**FR** Lanterne en verre avec finitions en métal. Adaptée aux environnements classiques et modernes, idéale pour décorer votre maison en apportant lumière et chaleur. Bougie non incluse.



WD718B  
8 053300 576326



WD718R  
8 053300 576319



WD718RO  
8 053300 576340



WD718V  
8 053300 576333

### WD719

**IT** Lanterna in vetro con finiture in metallo. Adatta ad ambienti classici e moderni, ideale per decorare la tua casa donando luce e calore. Candela non inclusa.

**EN** Glass lantern with metal finishes. Suitable for both classic and modern environments, ideal for decorating your home by providing light and warmth. Candle not included.

**FR** Lanterne en verre avec finitions en métal. Adaptée aux environnements classiques et modernes, idéale pour décorer votre maison en apportant lumière et chaleur. Bougie non incluse.



WD719B  
8 053300 576364



WD719R  
8 053300 576357



WD719RO  
8 053300 576388



WD719V  
8 053300 576371

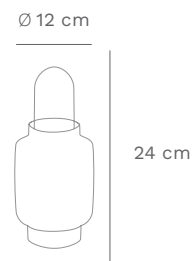

Lavare con un panno umido  
Wash with a damp cloth  
Nettoyer avec un chiffon humide

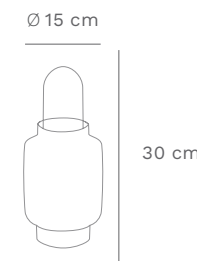

Lavare con un panno umido  
Wash with a damp cloth  
Nettoyer avec un chiffon humide



**WD767**

**IT Sgabello in ceramica con finitura lucida.** Un articolo d'arredo che ti permetterà di donare luce ed originalità alla tua casa, perfetto sia come seduta sia come tavolino.

**EN Ceramic stool with a glossy finish.** A furnishing item that will allow you to bring light and originality to your home, perfect both as a seat and as a small table.

**FR Tabouret en céramique avec finition brillante.** Un élément d'ameublement qui vous permettra d'apporter de la lumière et de l'originalité à votre maison, parfait à la fois comme siège et comme petite table.



WD767AR



8 053300 578153



WD767B



8 053300 578139



WD767BL



8 053300 578160



WD767N



8 053300 578146

Ø 33 cm



45 cm



Lavare con un panno umido  
Wash with a damp cloth  
Nettoyer avec un chiffon humide

## WD711

**IT Sgabello in ceramica con finitura lucida.** Un articolo d'arredo che ti permetterà di donare luce ed originalità alla tua casa, perfetto sia come seduta sia come tavolino.

**EN Ceramic stool with a polished finish.** A piece of furniture that will allow you to add light and originality to your home, perfect both as a seat and as a coffee table.

**FR Tabouret en céramique avec une finition polie.** Un meuble qui vous permettra d'apporter de la lumière et de l'originalité à votre intérieur, parfait aussi bien comme siège que comme table basse.



WD711AN



8 053300 575688



WD711CR



8 053300 575695



WD711R



8 053300 575701



WD711V



8 053300 575718

Ø 33 cm



42,5 cm



Lavare con un panno umido  
Wash with a damp cloth  
Nettoyer avec un chiffon humide



## WD686

**IT Portacandele in vetro borosilicato.** Si adatta perfettamente ad ambienti classici e moderni; ideale per decorare in maniera originale la tua tavola e la tua casa. Può essere utilizzato anche come portafiori o centrotavola. Candela non inclusa. Confezionata in scatola regalo FSC.

**EN Borosilicate glass candle holder.** It fits perfectly in classic and modern environments; ideal for decorating your table and home in an original way. It can also be used as a flower holder or centrepiece. Candle not included. Packaged in FSC gift box.

**FR Bougeoir en verre borosilicate.** Il s'intègre parfaitement dans les environnements classiques et modernes; idéal pour décorer votre table et votre maison de manière originale. Il peut également être utilisé comme porte-fleurs ou centre de table. Bougie non incluse. Emballé dans une boîte cadeau FSC.



WD686CE



8 053300 575053

WD686GI



8 053300 575046



WD686R



8 053300 575305

WD686TR



8 053300 575039

Ø 8,5 cm

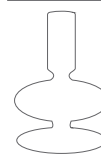

12 cm



Lavare con un panno umido  
Wash with a damp cloth  
Nettoyer avec un chiffon humide

## WD687

**IT Portacandele in vetro borosilicato.** Si adatta perfettamente ad ambienti classici e moderni; ideale per decorare in maniera originale la tua tavola e la tua casa. Può essere utilizzato anche come portafiori o centrotavola. Candela non inclusa. Confezionata in scatola regalo FSC.

**EN Borosilicate glass candle holder.** It fits perfectly in classic and modern environments; ideal for decorating your table and home in an original way. It can also be used as a flower holder or centrepiece. Candle not included. Packaged in FSC gift box.

**FR Bougeoir en verre borosilicate.** Il s'intègre parfaitement dans les environnements classiques et modernes; idéal pour décorer votre table et votre maison de manière originale. Il peut également être utilisé comme porte-fleurs ou centre de table. Bougie non incluse. Emballé dans une boîte cadeau FSC.



WD687PET



8 053300 575084

WD687R



8 053300 575312



Ø 5 cm

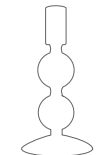

16 cm



Lavare con un panno umido  
Wash with a damp cloth  
Nettoyer avec un chiffon humide

WD687RO



8 053300 575077

WD687TR



8 053300 575060

## WD688

**IT Portacandele in vetro borosilicato.** Si adatta perfettamente ad ambienti classici e moderni; ideale per decorare in maniera originale la tua tavola e la tua casa. Può essere utilizzato anche come portafiori o centrotavola. Candela non inclusa. Confezionata in scatola regalo FSC.

**EN Borosilicate glass candle holder.** It fits perfectly in classic and modern environments; ideal for decorating your table and home in an original way. It can also be used as a flower holder or centrepiece. Candle not included. Packaged in FSC gift box.

**FR Bougeoir en verre borosilicate.** Il s'intègre parfaitement dans les environnements classiques et modernes; idéal pour décorer votre table et votre maison de manière originale. Il peut également être utilisé comme porte-fleurs ou centre de table. Bougie non incluse. Emballé dans une boîte cadeau FSC.



WD688BL



8 053300 575114



WD688R



8 053300 575329

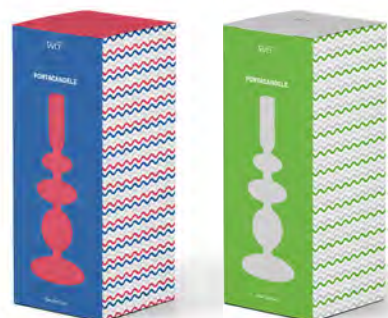

WD688TR



8 053300 575091



WD688V



8 053300 575107

Ø 8,5 cm



20 cm



Lavare con un panno umido  
Wash with a damp cloth  
Nettoyer avec un chiffon humide



**WD689**

**IT Portacandele in vetro borosilicato.** Si adatta perfettamente ad ambienti classici e moderni; ideale per decorare in maniera originale la tua tavola e la tua casa. Può essere utilizzato anche come portafiori o centrotavola. Candela non inclusa. Confezionata in scatola regalo FSC.

**EN Borosilicate glass candle holder.** It fits perfectly in classic and modern environments; ideal for decorating your table and home in an original way. It can also be used as a flower holder or centrepiece. Candle not included. Packaged in FSC gift box.

**FR Bougeoir en verre borosilicate.** Il s'intègre parfaitement dans les environnements classiques et modernes; idéal pour décorer votre table et votre maison de manière originale. Il peut également être utilisé comme porte-fleurs ou centre de table. Bougie non incluse. Emballé dans une boîte cadeau FSC.



WD689LI  
8 053300 575138



WD689R  
8 053300 575336



WD689PE  
8 053300 575145



WD689TR  
8 053300 575121

Ø 8,5 cm

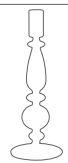

25 cm



Lavare con un panno umido  
Wash with a damp cloth  
Nettoyer avec un chiffon humide

**WD690**

**IT Porta tealight in vetro borosilicato.** Oggetto originale e colorato perfetto per rendere l'atmosfera in casa più accogliente e romantica. Perfetto anche come centrotavola decorativo. Tealight non inclusa. Si consiglia di utilizzare candele con rivestimento in alluminio. Confezionata in scatola regalo FSC.

**EN Borosilicate glass tealight holder.** Original and colourful object perfect for making the atmosphere in the house cozier and more romantic. Also perfect as a decorative centrepiece. We recommend using aluminium-coated candles. Tealight not included. Packaged in FSC gift box.

**FR Porte-bougies à réchaud en verre borosilicate.** Objet original et coloré, parfait pour rendre l'atmosphère de la maison plus chaleureuse et romantique. Parfait également comme centre de table décoratif. Nous recommandons d'utiliser des bougies recouvertes d'aluminium. Bougie à réchaud non incluse. Emballé dans une boîte cadeau FSC.



WD690LI  
8 053300 575176



WD690TR  
8 053300 575152



WD690R  
8 053300 575183



WD690V  
8 053300 575169

Ø 8,5 cm



22 cm



Lavare con un panno umido  
Wash with a damp cloth  
Nettoyer avec un chiffon humide



**WD751**

**IT Portacandele in vetro borosilicato con forma ad albero di Natale.** Oggetto originale e colorato perfetto per rendere l'atmosfera in casa più accogliente e romantica durante le feste. Confezionata in scatola regalo FSC.

**EN Borosilicate glass candle holder, Christmas tree shape.** Original and colourful object perfect for making the atmosphere in the house cozier and more romantic during the holidays. Packaged in FSC gift box.

**FR Bougeoir en verre borosilicaté, forme sapin de Noël.** Objet original et coloré parfait pour rendre l'atmosphère de la maison plus chaleureuse et romantique pendant les vacances. Emballé dans une boîte cadeau FSC.



WD751R



WD751TR



WD751V



Ø 9 cm

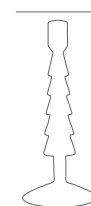

22 cm



Lavare con un panno umido  
Wash with a damp cloth  
Nettoyer avec un chiffon humide



# ANVERSA LINE



## WD819 *New*

**IT Set 4 bicchieri in vetro con molature.** Dai colori brillanti e i pattern originali renderanno la tua tavola ancora più iconica. Capacità: 300 ml.

**EN Set of 4 glass tumblers with engravings.** With bright colors and original patterns, they will make your table even more iconic. Capacity: 300 ml.

**FR Set de 4 gobelets en verre avec décors incisés.** Décors aux couleurs vives et géométriques, ils rendront votre table encore plus élégante. Contenance : 300 ml.

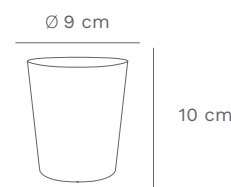

**WD818** *New*

**IT** Cofanetto in vetro ideale per custodire oggetti preziosi. Dai colori brillanti renderà gli ambienti della tua casa ancora più originali ed iconici. Interno in velluto.

**EN** Glass case ideal for storing precious item. Its bright colors will make the rooms in your house even more original and iconic. Velvet interior.

**FR** Coffret en verre idéal pour conserver des objets précieux. Avec ses couleurs vives, il rendra les espaces de votre maison encore plus originaux et emblématiques. Intérieur en velours.



WD818AR  
8 055035 680668



WD818RO  
8 055035 680651

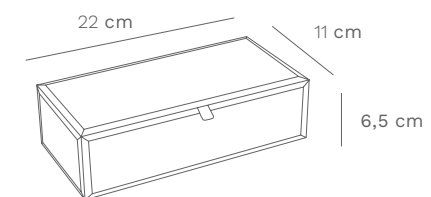

Lavare con un panno umido  
Wash with a damp cloth  
Nettoyer avec un chiffon humide



## WD816 *New*

**IT Cofanetto in vetro ideale per custodire oggetti preziosi.** Dai colori brillanti renderà gli ambienti della tua casa ancora più originali ed iconici. Interno in velluto.

**EN Glass case ideal for storing precious item.** Its bright colors will make the rooms in your house even more original and iconic. Velvet interior.

**FR Coffret en verre idéal pour conserver des objets précieux.** Avec ses couleurs vives, il rendra les espaces de votre maison encore plus originaux et emblématiques. Intérieur en velours.

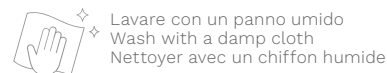
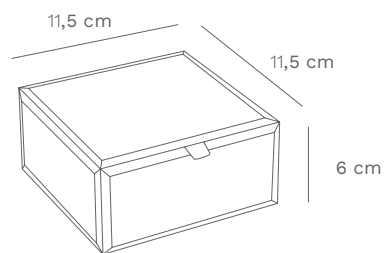

## WD817 *New*

**IT Cofanetto in vetro ideale per custodire oggetti preziosi.** Dai colori brillanti renderà gli ambienti della tua casa ancora più originali ed iconici. Interno in velluto.

**EN Glass case ideal for storing precious item.** Its bright colors will make the rooms in your house even more original and iconic. Velvet interior.

**FR Coffret en verre idéal pour conserver des objets précieux.** Avec ses couleurs vives, il rendra les espaces de votre maison encore plus originaux et emblématiques. Intérieur en velours.

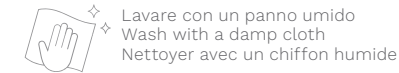
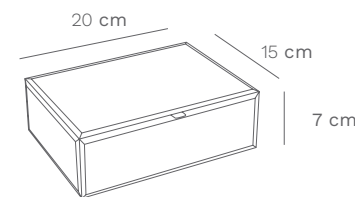



**WD761**

**IT Bicchiere cocktail** in vetro con base effetto diamante. Un articolo originale e colorato, perfetto per rendere i tuoi aperitivi e le tue serate ancora più iconiche.

**EN Cocktail glass** with diamond effect base. An original and colorful item, perfect for making your aperitifs and evenings even more iconic.

**FR Verre à cocktail** avec base à effet diamant. Un article original et coloré, parfait pour rendre vos apéritifs et soirées encore plus emblématiques.



WD761AR  
8 053300 578054



WD761AZ  
8 053300 578016



WD761G  
8 053300 578030



WD761PE  
8 053300 578023

 No lavastoviglie  
No dishwasher  
Pas de lave-vaisselle  
 No microonde  
No microwave  
Pas de micro-ondes

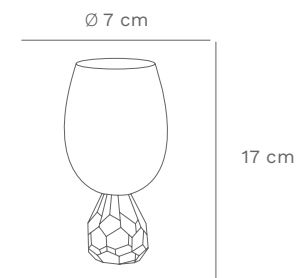

WD761R  
8 053300 578047



WD761VI  
8 053300 578061



### WD762

**IT Alzata in vetro** con base effetto diamante. Elegante ed originale, perfetta per servire dolci e torte rendendo la tua tavola iconica.

**EN Glass cake stand** with diamond effect base. Elegant and original, perfect for serving desserts and cakes making your table iconic.

**FR Plateau surélevé en verre** avec base à effet diamant. Élégant et original, parfait pour servir des desserts et des gâteaux en rendant votre table iconique.

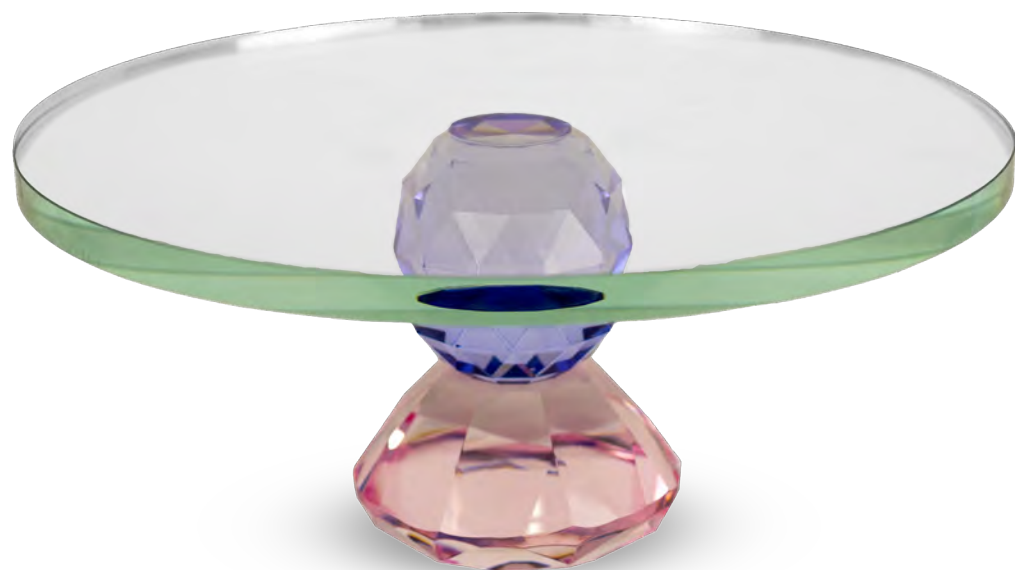

WD762



8 053300 578078

Ø 23,5 cm

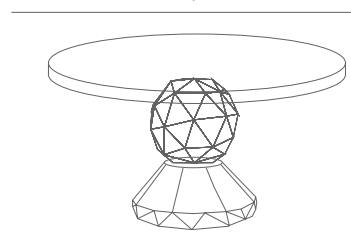

10,5 cm



No lavastoviglie  
No dishwasher  
Pas de lave-vaisselle



No microonde  
No microwave  
Pas de micro-ondes



### WD763, WD764, WD765

**IT Porta candela effetto diamante.** Simpatico e colorato ti permette di rendere ogni ambiente originale ed iconico.

**EN Diamond effect candle holder.** Cheerful and colorful, it allow you to make every environment original and iconic.

**FR Porte-bougie à effet diamant.** Gais et colorés, ils vous permettent de rendre chaque environnement original et iconique.



WD763A



8 053300 578085



WD764A



8 053300 578092



WD765A



8 053300 578108

Ø 6,4 cm

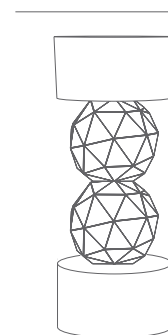

14,5 cm



Ø 6,4 cm

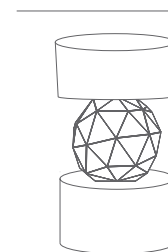

11 cm



Ø 6,4 cm

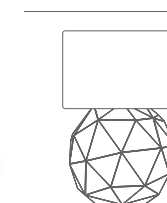

7 cm



Lavare con un panno umido  
Wash with a damp cloth  
Nettoyer avec un chiffon humide

# TOKYO LINE



## WD720

**IT** Neon decorativo per illuminare ogni ambiente della tua casa con uno stile originale ed iconico. Alimentazione a parete. Presa USB-A e interruttore ON/OFF inclusi. Input: 5.0V 1A (USB). Potenza: 5W.

**EN** Decorative neon to illuminate every room in your home with an original and iconic style. Wall power supply. USB-A socket and ON/OFF switch included. Input: 5.0V 1A (USB). Power: 5W.

**FR** Néon décoratif pour illuminer chaque pièce de votre maison avec un style original et emblématique. Alimentation murale. Port USB-A et interrupteur ON/OFF inclus. Entrée: 5.0V 1A (USB). Puissance: 5W.



WD720CHE



8 053300 576395



WD720DRE



8 053300 576425



WD720HAP



8 053300 576418



WD720HOM *New*



8 053300 579358



WD720LOV



8 053300 576401



WD720REL *New*



8 053300 579365

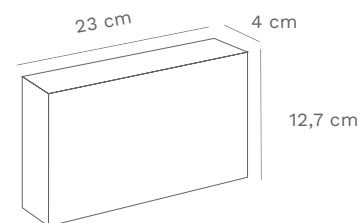

Luce a led  
Led light  
Lumière LED



Cavo USB  
USB cable  
Cable USB



Interruttore on-off  
On-off switch  
Bouton on/off



## WD785 *New*

**IT** Neon decorativo per illuminare ogni ambiente della tua casa con uno stile originale ed iconico. Alimentazione a parete. Presa USB-A e interruttore ON/OFF inclusi. Input: 5.0V 1A (USB). Potenza: 5W.

**EN** Decorative neon to illuminate every room in your home with an original and iconic style. Wall power supply. USB-A socket and ON/OFF switch included. Input: 5.0V 1A (USB). Power: 5W.

**FR** Néon décoratif pour illuminer chaque pièce de votre maison avec un style original et emblématique. Alimentation murale. Port USB-A et interrupteur ON/OFF inclus. Entrée: 5.0V 1A (USB). Puissance: 5W.



WD785CES



8 053300 579389



WD785DRA



8 053300 579372

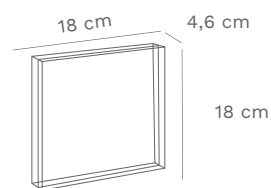

Luce a led  
Led light  
Lumière LED



Cavo USB  
USB cable  
Cable USB



Interruttore on-off  
On-off switch  
Bouton on/off

## WD786 *New*

**IT** Neon decorativo per illuminare ogni ambiente della tua casa con uno stile originale ed iconico. Alimentazione a parete. Presa USB-A e interruttore ON/OFF inclusi. Input: 5.0V 1A (USB). Potenza: 5W.

**EN** Decorative neon to illuminate every room in your home with an original and iconic style. Wall power supply. USB-A socket and ON/OFF switch included. Input: 5.0V 1A (USB). Power: 5W.

**FR** Néon décoratif pour illuminer chaque pièce de votre maison avec un style original et emblématique. Alimentation murale. Port USB-A et interrupteur ON/OFF inclus. Entrée: 5.0V 1A (USB). Puissance: 5W.



WD786PEA



8 053300 579402



WD786YOU



8 053300 579396

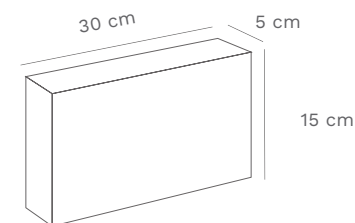

Luce a led  
Led light  
Lumière LED



Cavo USB  
USB cable  
Cable USB



Interruttore on-off  
On-off switch  
Bouton on/off



**WD760**

**IT Specchio neon decorativo.** Da appendere al muro o da tenere sulla scrivania, è perfetto per illuminare la tua casa con uno stile originale ed iconico. Alimentazione a parete. Presa USB-A e interruttore ON/OFF inclusi.

**EN Decorative neon mirror.** To hang on the wall or place on the desk, it's perfect for illuminating your home with an original and iconic style. Wall power supply. USB-A socket and ON/OFF switch included.

**FR Miroir néon décoratif.** À accrocher au mur ou à poser sur le bureau, il est parfait pour illuminer votre maison avec un style original et emblématique. Alimentation murale. Prise USB-A et interrupteur ON/OFF inclus.

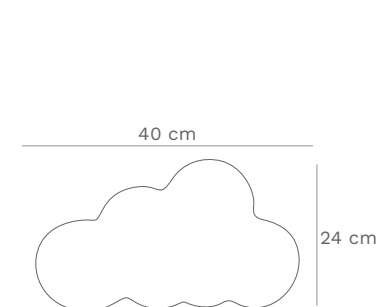

WD760NUV



8 053300 577996



Luce al LED  
LED light  
Lumière LED



Cavo USB  
USB cable  
Cable USB



Interruttore on-off  
On-off switch  
Bouton on-off

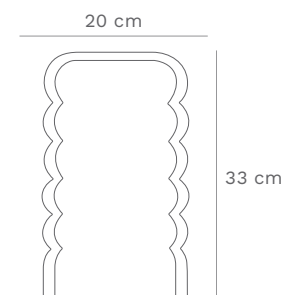

WD760ROS



8 053300 577989



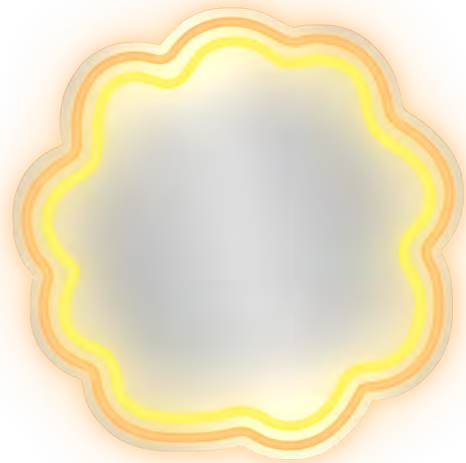

WD760ARA



WD760CUO

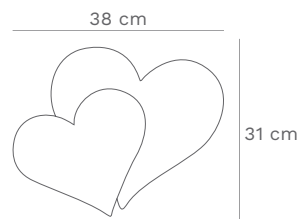
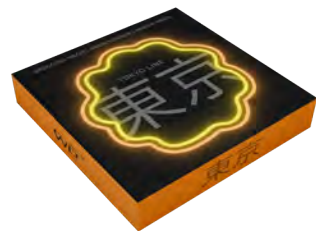
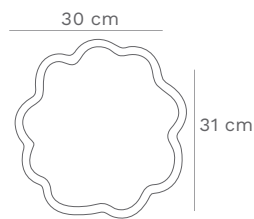

Luce al LED  
LED light  
Lumière LED



Cavo USB  
USB cable  
Cable USB



Interruttore on-off  
On-off switch  
Bouton on-off



# FREIBURG LINE



## WD759

**IT Orologio a cucù** da appendere al muro oppure da collocare sulle tue scaffalature per rendere ogni ambiente più allegro ed originale. Lasciati accompagnare dal dolce cinguettio dell'uccellino allo scoccare di ogni ora. 3 batterie AA incluse. Pendolo removibile.

**EN Cuckoo clock** to hang on the wall or place on your shelves to make every room more cheerful and original. Let yourself be accompanied by the sweet chirping of the bird at every hour. 3 AA batteries included. Removable pendulum.

**FR Horloge coucou** à accrocher au mur ou à poser sur vos étagères pour rendre chaque pièce plus joyeuse et originale. Laissez-vous accompagner par le doux gazouillement de l'oiseau à chaque heure. 3 piles AA incluses. Pendule amovible.



WD759AVI



8 053300 577255



WD759B



8 053300 577828



WD759G



8 053300 577835

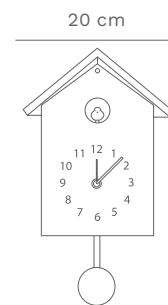

34,5 cm



3 batterie AA incluse  
3 AA batteries included  
3 piles AA incluses



WD759N



8 053300 577811



WD759R *New*



8 053300 579013



WD759V *New*



8 053300 579006

## MYKONOS LINE

WD784 *New*

**IT** Tovaglietta double-face. Con sfondo colorato e stampa collage. Il retro in tinta unita colore grigio. Ideale per le tue mise en place, dona colore ed allegria alla tua tavola. Materiale: PVC.

**EN** Double-sided placemat with a colored background and collage print. Solid gray on the back. Ideal for your table settings, they add color and cheerfulness to your table. Material: PVC.

**FR** Set de table réversible avec un fond coloré et une impression de collage sur le recto; gris uni sur le verso. Idéal pour vos mises en place, ils ajoutent de la couleur et de la gaieté à votre table. Matériau: PVC.



WD784CON



8 053300 579341



WD784FAR



8 053300 579327



WD784TAR



8 053300 579310

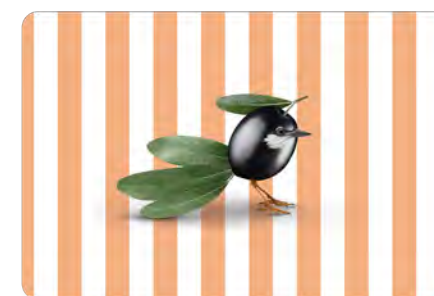

WD784OLI



8 053300 579297



WD784PAG



8 053300 579334

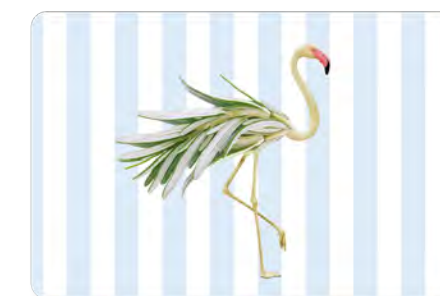

WD784FEN



8 053300 579303

45 cm



30 cm



Lavare con un panno umido  
Wash with a damp cloth  
Nettoyer avec un chiffon humide

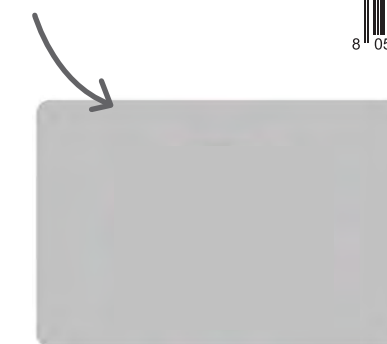

*Retro in tinta unita  
The back in solid color  
Uni sur le verso*

## WD814 *New*

**IT Tagliere in vetro temperato.** Dai colori vivaci e con stampa collage è perfetto per dare un tocco di stile e allegria alla tua cucina.

**EN Colorful tempered glass cutting board.** The cutting board with a collage print is perfect for adding a touch of style and cheer to your kitchen.

**FR Planche à découper en verre trempé.** Aux couleurs vives avec une impression collage est parfaite pour ajouter une touche de style et de gaieté à votre cuisine.

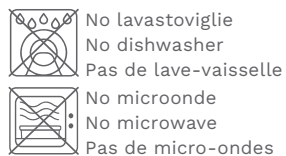
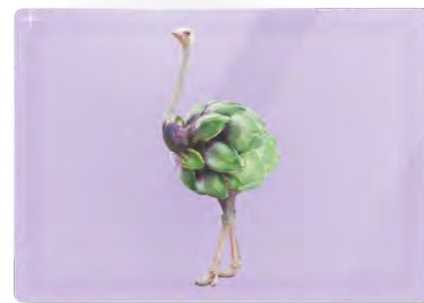

## WD815 *New*

**IT Set 4 sottobicchieri in ceramica con base in sughero,** sono perfetti per rendere unico ogni posto a tavola. A completare il set un grazioso contenitore in ceramica.

**EN Set of 4 ceramic coasters with cork base,** they are perfect for making each place setting unique. To complete the set, a nice ceramic container.

**FR Set de 4 sous-verres en céramique avec base en liège,** parfaits pour apporter une touche d'élégance et de singularité à chaque place à table. Le set est accompagné d'un ravissant contenant en céramique, idéal pour un rangement pratique et esthétique.

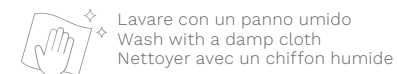
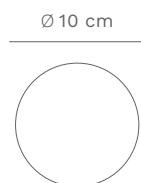

## WD813 *New*

**IT Canovaccio in lino.** Dalle ottime capacità assorbenti e resistenti, oltre ad essere molto pratico ed efficiente, dona un tocco di originalità alla tua cucina grazie alle sue stampe collage su sfondo in colori naturali.

**EN Linen kitchen towel.** Known for its excellent absorbent and durable qualities, it is also very practical and efficient, adding a touch of originality to your kitchen with its collage prints on a background of natural colors.

**FR Torchon en lin.** Doté d'excellentes capacités absorbantes et résistantes, il est très pratique et efficace. Ce torchon apporte une touche d'originalité à votre cuisine grâce à ses imprimés collage sur un fond de couleurs naturelles.



WD813AGL



8 055035 680149



WD813CAR



8 055035 680156

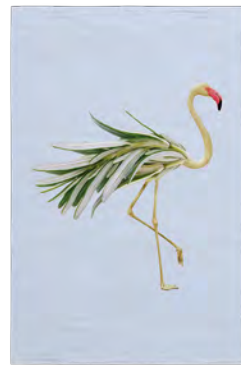

WD813ROS



8 055035 680163



WD813BIE



8 055035 680170

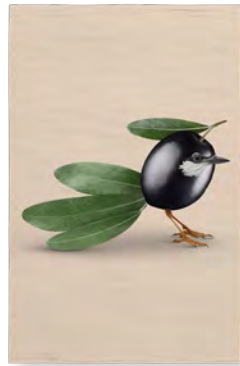

WD813OLI



8 055035 680187



WD813CAV



8 055035 680194



Lavabile a 30°  
Washable at 30°  
Lavable à 30°



Si ferro da stiro  
Iron safe  
Fer à repasser

## WD721

**IT Tovaglietta double-face. Con sfondo colorato e stampa collage.** Il retro in tinta unita colore grigio. Ideale per le tue mise en place, dona colore ed allegria alla tua tavola. Materiale: PVC.

**EN Double-sided placemat with a colored background and collage print.** Solid gray on the back. Ideal for your table settings, they add color and cheerfulness to your table. Material: PVC.

**FR Set de table réversible avec un fond coloré et une impression de collage sur le recto;** gris uni sur le verso. Idéal pour vos mises en place, ils ajoutent de la couleur et de la gaieté à votre table. Matériau: PVC.



WD721ALL



8 053300 576227



WD721ARA



8 053300 576234



WD721DEL



8 053300 576258



WD721POL



8 053300 576241



WD721RAN



8 053300 576272



WD721TAR



8 053300 576265

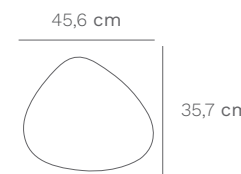

Lavare con un panno umido  
Wash with a damp cloth  
Nettoyer avec un chiffon humide



*Retro in tinta unita  
The back in solid color  
Uni sur le verso*

## WD757

**IT** Piatto pizza in porcellana con fondo colorato e stampa collage. Componi la tua mise en place con colore ed allegria donando originalità alla tua tavola.

**EN** Porcelain pizza plate with colored bottom and collage print. Compose your mise en place with color and joy, adding originality to your table.

**FR** Assiette à pizza en porcelaine avec fond coloré et impression de collage. Composez votre mise en place avec couleur et joie, ajoutant de l'originalité à votre table.



WD757CAS



8 053300 577712



WD757FAR



8 053300 577767



WD757OLI



8 053300 577750



WD757PAL



8 053300 577743



WD757POL



8 053300 577736



WD757RAC



8 053300 577729

Ø 30,5 cm

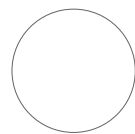

Si lavastoviglie  
Dishwasher safe  
Lave-vaisselle possible



Si microonde  
Microwave safe  
Micro-ondes possible





### WD755

**IT Sottopentola in ceramica** colorato, stampa collage e fondo in sughero. Simpatico e colorato, dona colore ed allegria alla tua tavola e alla tua cucina. Perfetto anche come oggetto decorativo.

**EN Ceramic trivet** colorful, collage print, and cork backing. Cheerful and colorful, it adds color and joy to your table and kitchen. Perfect also as a decorative object.

**FR Dessous-de-plat en céramique** coloré, impression collage et dos en liège. Agréable et coloré, apporte de la couleur et de la joie à votre table et à votre cuisine. Parfait également comme objet décoratif.



WD755ARA



WD755CAN



WD755FEN



WD755PAP



WD755POL



WD755TAR



Ø 18 cm

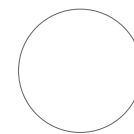

Lavare con un panno umido  
Wash with a damp cloth  
Nettoyer avec un chiffon humide



**WD691, WD692, WD693, WD694, WD758** *New*

**IT Vassoio con fondo colorato e stampa collage.** Perfetto sia come vassoio sia come articolo decorativo, dai colori accesi e i decori simpatici donerà colore ed allegria alla tua cucina e alla tua casa. Il materiale in polipropilene ne permette una lunga durata ed una facile pulizia.

**EN Tray with coloured background and collage print.** Perfect both as a tray and as a decorative item; with its bright colours and cute decorations it will bring colour and cheer to your kitchen and home. The polypropylene material makes it long-lasting and easy to clean.

**FR Plateau avec fond coloré et impression d'un collage.** Parfait à la fois comme plateau et comme objet de décoration, avec ses couleurs vives et ses jolies décorations, il apportera de la couleur et de la gaieté à votre cuisine et à votre maison. Le matériau en polypropylène le rend durable et facile à nettoyer.

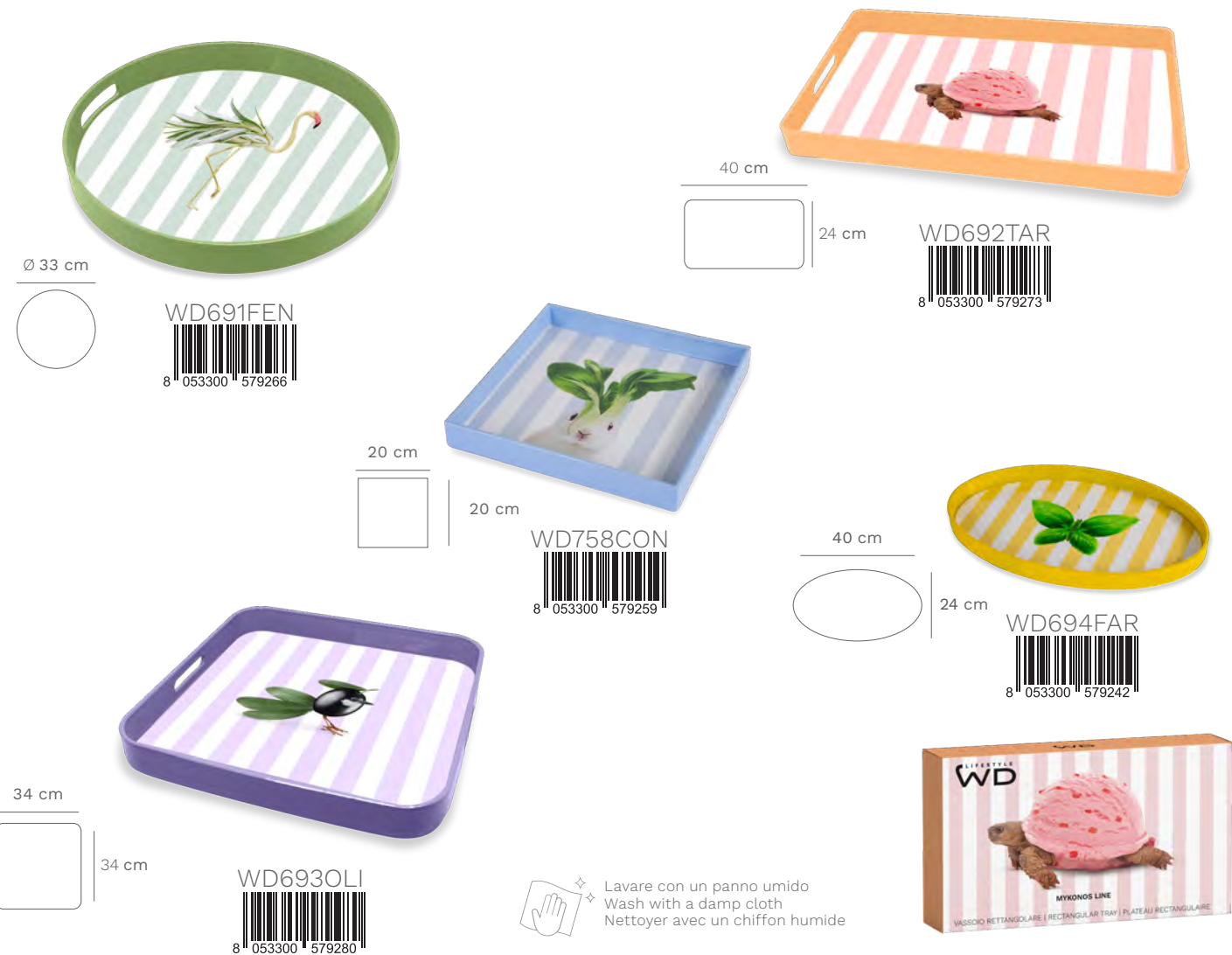

**WD691**

**IT Vassoio con fondo colorato e stampa collage.** Perfetto sia come vassoio sia come articolo decorativo, dai colori accesi e i decori simpatici donerà colore ed allegria alla tua cucina e alla tua casa. Il materiale in polipropilene ne permette una lunga durata ed una facile pulizia. Dimensione: Ø 33 cm H: 4 cm.

**EN Tray with coloured background and collage print.** Perfect both as a tray and as a decorative item; with its bright colours and cute decorations it will bring colour and cheer to your kitchen and home. The polypropylene material makes it long-lasting and easy to clean. Size: Ø 33 cm H: 4 cm.

**FR Plateau avec fond coloré et impression d'un collage.** Parfait à la fois comme plateau et comme objet de décoration, avec ses couleurs vives et ses jolies décorations, il apportera de la couleur et de la gaieté à votre cuisine et à votre maison. Le matériau en polypropylène le rend durable et facile à nettoyer. Taille : Ø 33 cm H: 4 cm.



**WD692**

**IT Vassoio con fondo colorato e stampa collage.** Perfetto sia come vassoio sia come articolo decorativo, dai colori accesi e i decori simpatici donerà colore ed allegria alla tua cucina e alla tua casa. Il materiale in polipropilene ne permette una lunga durata ed una facile pulizia. Dimensione: L 40 I 24 H 3,50 cm.

**EN Tray with coloured background and collage print.** Perfect both as a tray and as a decorative item; with its bright colours and cute decorations it will bring colour and cheer to your kitchen and home. The polypropylene material makes it long-lasting and easy to clean. Size: W 40 I 24 H 3.50 cm.

**FR Plateau avec fond coloré et impression d'un collage.** Parfait à la fois comme plateau et comme objet de décoration, avec ses couleurs vives et ses jolies décorations, il apportera de la couleur et de la gaieté à votre cuisine et à votre maison. Le matériau en polypropylène le rend durable et facile à nettoyer. Taille : L 40 I 24 H 3,5 cm.



WD692CIG



8 053300 575657



WD692PAP



8 053300 575237

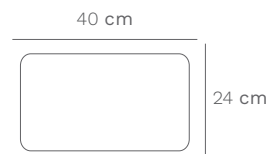

Lavare con un panno umido  
Wash with a damp cloth  
Nettoyer avec un chiffon humide

**WD693**

**IT Vassoio con fondo colorato e stampa collage.** Perfetto sia come vassoio sia come articolo decorativo, dai colori accesi e i decori simpatici donerà colore ed allegria alla tua cucina e alla tua casa. Il materiale in polipropilene ne permette una lunga durata ed una facile pulizia. Dimensione: L 34 I 34 H 4 cm.

**EN Tray with coloured background and collage print.** Perfect both as a tray and as a decorative item; with its bright colours and cute decorations it will bring colour and cheer to your kitchen and home. The polypropylene material makes it long-lasting and easy to clean. Size: W 34 I 34 H 4 cm.

**FR Plateau avec fond coloré et impression d'un collage.** Parfait à la fois comme plateau et comme objet de décoration, avec ses couleurs vives et ses jolies décorations, il apportera de la couleur et de la gaieté à votre cuisine et à votre maison. Le matériau en polypropylène le rend durable et facile à nettoyer. Taille : L 34 I 34 H 4 cm.



WD693CAN



8 053300 575664

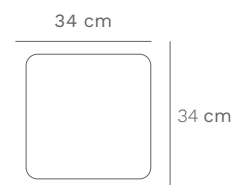

Lavare con un panno umido  
Wash with a damp cloth  
Nettoyer avec un chiffon humide



WD693PAG



8 053300 575244



## WD694

**IT Vassoio svuotatasche con fondo colorato e stampa collage.** Perfetto sia come vassoio sia come articolo decorativo, dai colori accesi e i decori simpatici donerà colore ed allegria alla tua cucina e alla tua casa. Il materiale in polipropilene ne permette una lunga durata ed una facile pulizia. Dimensione: L 28 l 17 H 2 cm.

**EN Emptying tray with coloured background and a collage print.** Perfect both as a tray and as a decorative item, its bright colours and cute decorations will bring colour and cheer to your kitchen and home. The polypropylene material makes it long-lasting and easy to clean. Dimensions: W 28 l 17 H 2 cm.

**FR Plateau vide-poches avec fond coloré et impression d'un collage.** Parfait à la fois comme plateau et comme objet de décoration, ses couleurs vives et ses jolies décorations apporteront de la couleur et de la gaieté à votre cuisine et à votre maison. Le matériau en polypropylène le rend durable et facile à nettoyer. Taille : L 28 l 17 H 2 cm.



WD694FEN  
8 053300 575251



WD694GAL  
8 053300 575671

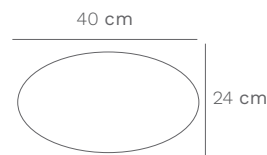

 Lavare con un panno umido  
 Wash with a damp cloth  
 Nettoyer avec un chiffon humide

## WD758 *New*

**IT Vassoio e svuota tasche con fondo colorato e stampa collage.** Perfetto anche come articolo decorativo. I simpatici collage doneranno allegria e originalità alla tua casa.

**EN Tray and pocket emptier with colored base and collage print.** Perfect as a decorative item. The cheerful collages will bring joy and originality to your home.

**FR Plateau et vide-poches avec fond coloré et impression de collage.** Parfait aussi comme article décoratif. Les joyeux collages apporteront de la joie et de l'originalité à votre maison.



WD758MAC  
8 055035 680453



WD758UOV  
8 055035 680446

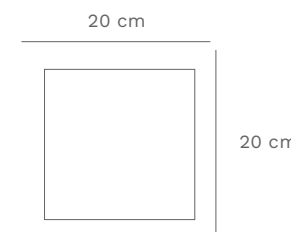

 Lavare con un panno umido  
 Wash with a damp cloth  
 Nettoyer avec un chiffon humide



### WD758

**IT Vassoio e svuota tasche** con fondo colorato, bordo oro e stampa collage natalizia. Perfetto anche come articolo decorativo. I simpatici collage doneranno allegria e originalità alla tua casa durante le feste.

**EN Tray and pocket emptier** with colored base, gold rim, and Christmas collage print. Perfect as a decorative item. The cheerful collages will bring joy and originality to your home during the holidays.

**FR Plateau et vide-poches** avec fond coloré, bordure dorée et impression de collage de Noël. Parfait aussi comme article décoratif. Les joyeux collages apporteront de la joie et de l'originalité à votre maison pendant les fêtes.

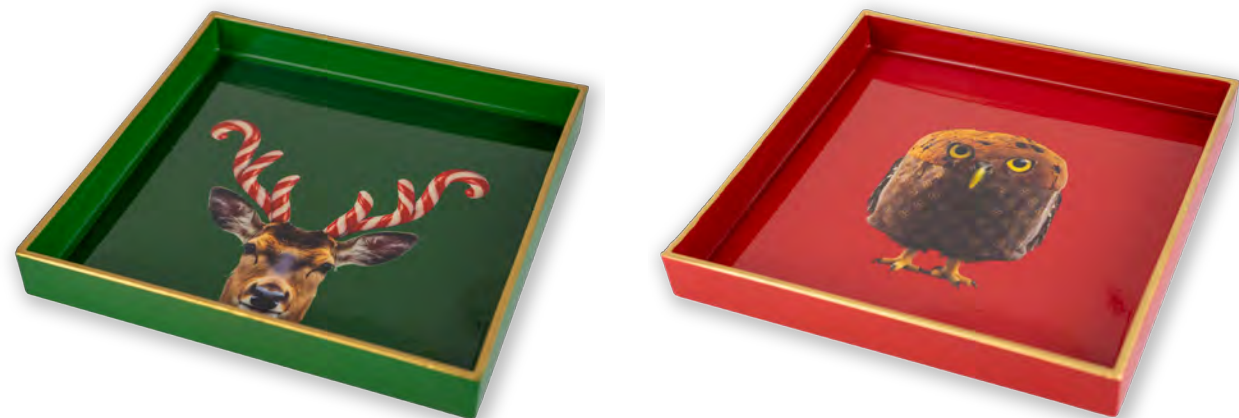

WD758COR



8 053300 577859

WD758PAN



8 053300 577842

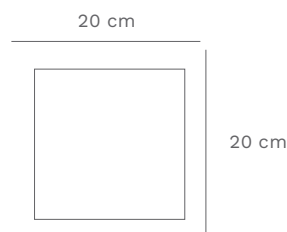

### WD755

**IT Sottopentola in ceramica** con fondo colorato, stampa collage e fondo in sughero. Simpatico e colorato, dona colore ed allegria alla tua tavola e alla tua cucina durante le feste. Perfetto anche come oggetto decorativo.

**EN Ceramic trivet** with colored base, collage print, and cork backing. Cheerful and colorful, adds color and joy to your table and kitchen during the holidays. Also perfect as a decorative object.

**FR Dessous-de-plat en céramique** avec base colorée, impression de collage et dos en liège. Sympathique et coloré, ajoute de la couleur et de la joie à votre table et à votre cuisine pendant les fêtes. Parfait également comme objet décoratif.



WD755COR



8 053300 577804

WD755PAN



8 053300 577798

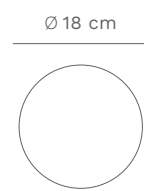

## WD756

**IT** Piatto panettone in porcellana con fondo colorato e stampa collage natalizia. Originale e colorato, perfetto per condividere momenti e squisiti dolci con familiari ed amici durante le feste. Dona colore ed allegria alla tua tavola.

**EN** Porcelain panettone plate with colored bottom and Christmas collage print. Original and colorful, perfect for sharing moments and delicious sweets with family and friends during the holidays. Adds color and joy to your table.

**FR** Assiette à panettone en porcelaine avec fond coloré et impression de collage de Noël. Originale et colorée, parfaite pour partager des moments et des délices avec la famille et les amis pendant les fêtes. Ajoute de la couleur et de la joie à votre table.



WD756COR



WD756PAN



Ø 30,5 cm

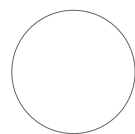

Si lavastoviglie  
Dishwasher safe  
Lave-vaisselle possible



Si microonde  
Microwave safe  
Micro-ondes possible



# AUSTIN LINE



## WD726

**IT Set pochette termica e asciugamano in microfibra.** Due accessori comodi per vivere con stile le tue giornate outdoor. Pochette adatta a riporre il tuo asciugamano, perfetta anche per tenere il tuo telefono, bibite e snack riparati da sole.

**EN Set of cooler pouch and microfiber towel.** Two convenient accessories to live your outdoor days in style. The pouch is suitable for storing your towel, perfect also for keeping your phone, drinks, and snacks sheltered from the sun.

**FR Set de pochette isotherme avec serviette en microfibre.** Deux accessoires pratiques pour vivre vos journées en plein air avec style. La pochette est idéale pour ranger votre serviette, parfaite également pour protéger votre téléphone, vos boissons et vos collations du soleil.



WD726BL



8 053300 575848



WD726OL



8 053300 579068

*New*

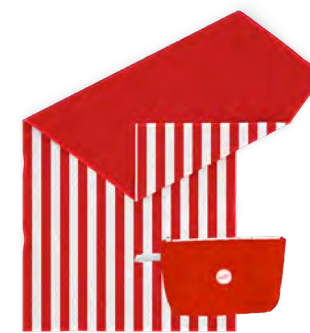

WD726R



8 053300 579051

*New*



WD726RO



8 053300 579044

*New*



Lavabile a 30°  
Washable at 30°  
Lavable à 30°



Si ferro da stiro  
Iron safe  
Fer à repasser

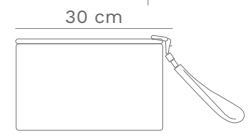
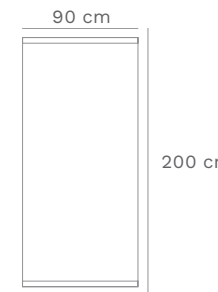

WD726AR



8 053300 575831



WD726GI



8 053300 575855



WD726V



8 053300 575862

## WD800 *New*

**IT Cuscino gonfiabile con federa in microfibra.** Perfetto da abbinare ai nostri teli mare per rendere la tua giornata in spiaggia ancora più rilassante.

**EN Inflatable pillow with a microfiber cover.** Perfect to pair with our beach towels to make your day at the beach even more relaxing.

**FR Coussin gonflable avec housse en microfibre.** Parfait pour compléter nos serviettes de plage et rendre votre journée à la plage encore plus relaxante.



WD800BL  
8 055035 680323



WD800OL  
8 055035 680330



WD800R  
8 055035 680354



WD800RO  
8 055035 680347

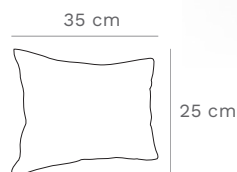

Lavabile a 30°  
Washable at 30°  
Lavable à 30°



Si ferro da stiro  
Iron safe  
Fer à repasser

## WD799 *New*

**IT Borsa Termica 8L.** Comoda e pratica, perfetta come porta pranzo. Ti permette di conservare al fresco cibo e bevande.

**EN Cooler bag, 8L.** Comfortable and practical, perfect as a lunch box. It allows you to keep food and drinks cool.

**FR Sac isotherme 8L :** pratique et facile à transporter, il est idéal comme sac-repas. Il maintient vos aliments et boissons au frais, parfait pour le bureau, les pique-niques ou les sorties en plein air.



WD799BL  
8 053300 579785



WD799OL  
8 053300 579822



WD799RO  
8 053300 579792



WD799R  
8 053300 579808



WD799GI  
8 053300 579815



Lavare con un panno umido  
Wash with a damp cloth  
Nettoyer avec un chiffon humide



**WD727**

**IT Borsa termica modello tote 18L.** Comoda e pratica, perfetta per mantenere al fresco cibo e bevande durante le giornate fuori porta o in ufficio.

**EN Tote cooler bag, 18L.** Comfortable and practical, perfect for keeping food and drinks cool during outdoor days or at the office.

**FR Sac isotherme de type tote, 18L.** Confortable et pratique, parfait pour maintenir au frais les aliments et les boissons lors des sorties en plein air ou au bureau.



WD727BL  
8 053300 575879

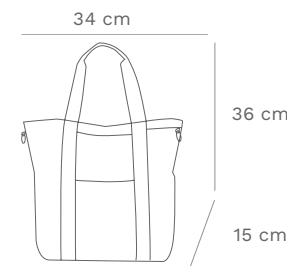

 Lavare con un panno umido  
Wash with a damp cloth  
Nettoyer avec un chiffon humide



WD727GI  
8 053300 575886

### WD728

**IT Zaino termico 16L.** Comodo e pratico, perfetto per mantenere al fresco cibo e bevande durante le giornate fuori porta.

**EN Cooler backpack 16L.** Comfortable and practical, perfect for keeping food and drinks cool during outdoor days.

**FR Sac à dos isotherme 16L.** Confortable et pratique, parfait pour maintenir au frais les aliments et les boissons lors des sorties en plein air.



WD728BL



8 053300 576586



WD728GI



8 053300 576593

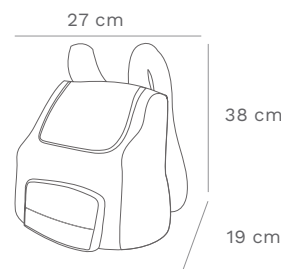

Lavare con un panno umido  
Wash with a damp cloth  
Nettoyer avec un chiffon humide

### WD729

**IT Borsa termica 25L con tasca portabottiglie.** Capiente e pratica, perfetta per mantenere al fresco cibo e bevande durante le giornate fuori porta.

**EN Cooler bag 25L with bottle holder pocket.** Spacious and practical, perfect for keeping food and drinks cool during outdoor days.

**FR Sac isotherme 25L avec poche porte-bouteille.** Spacieux et pratique, parfait pour maintenir au frais les aliments et les boissons lors des sorties en plein air.



WD729BL



8 053300 576609



WD729GI



8 053300 576616

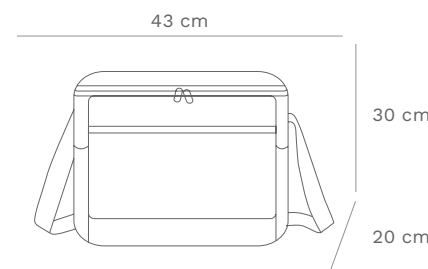

Lavare con un panno umido  
Wash with a damp cloth  
Nettoyer avec un chiffon humide

**WD812** *New*

**IT Porta zampironi in metallo con base e finitura sabbiata.** Dotato di griglia con pattern decorativo. Utilizzabile da terra grazie alla nuova base in metallo o da tavolo con manico pieghevole, da inserire nel terreno grazie al suo stelo (modulabile in altezza). Il magnete ti permette il suo miglior utilizzo con o senza stelo. Rendi ogni ambiente originale, colorato ma soprattutto al sicuro da tutti gli insetti. Zampirone escluso.

**EN Metal mosquito coil holder with base.** This holder features a decorative grill and can be placed on the ground with its metal base or on a table with its foldable handle. It can also be inserted into the ground with its adjustable height pole. A magnet allows for optimal use with or without the pole, making this holder both decorative and functional. It protects against insects while enhancing the space. Mosquito coil not included.

**FR Support de spirale anti-moustique en métal avec base.** Il est muni d'une grille décorative. Il peut être posé sur le sol grâce à sa base métallique ou sur une table avec un manche pliable. Il est également possible de l'insérer dans le sol avec sa tige ajustable en hauteur. Un aimant permet une utilisation optimale avec ou sans tige. Ce support décoratif et fonctionnel protège des insectes tout en embellissant l'espace. Spirale anti-moustique non incluse.

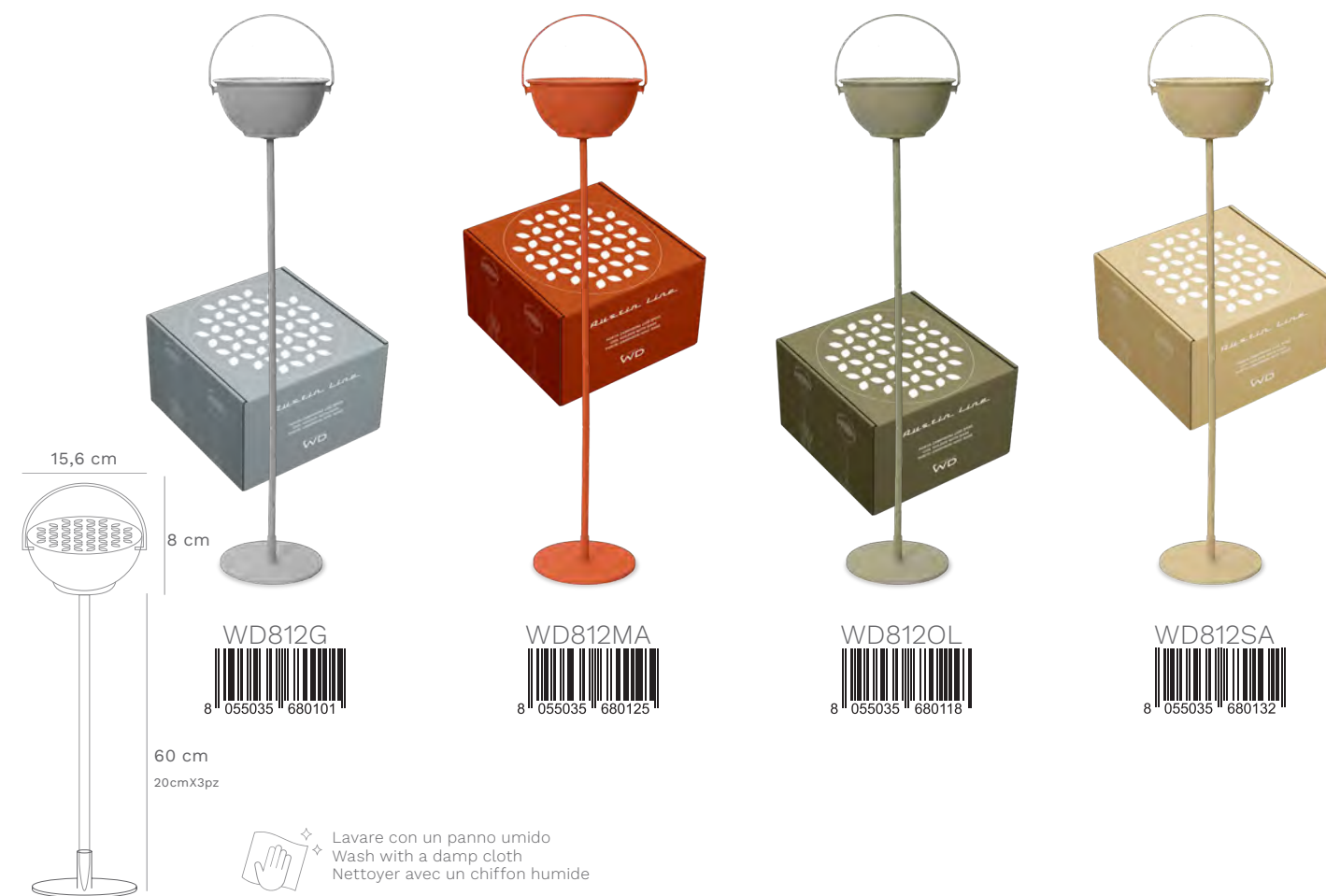

## WD725

**IT Porta zampironi in metallo.** Dotato di griglia con pattern decorativo, utilizzabile da tavolo con manico pieghevole oppure con stelo (modulabile in altezza) da inserire nel terreno per posizionarlo ovunque tu voglia. Il magnete ti permette il suo miglior utilizzo con o senza stelo. Rendi ogni ambiente originale, colorato ma soprattutto al sicuro da tutti gli insetti. Zampirone escluso.

**EN Metal mosquito trap holder.** Equipped with a grid with a decorative pattern, can be used on the table with a foldable handle or with a stem (adjustable in height) to be inserted into the ground for placement wherever you want. The magnet allows you to use it with or without the stem. Make every environment original, colorful, but above all, safe from all insects. Lantern not included.

**FR Support de lanterne en métal.** Équipé d'une grille avec un motif décoratif, peut être utilisé sur la table avec une poignée pliable ou avec une tige (réglable en hauteur) à insérer dans le sol pour le placer où vous le souhaitez. L'aimant vous permet de l'utiliser avec ou sans la tige. Rendez chaque environnement original, coloré, mais surtout à l'abri de tous les insectes. Lanterne non incluse.



WD725AN  
8 053300 576463



WD725AR  
8 053300 576487



WD725AZ *New*  
8 055035 680088



WD725BL  
8 053300 576500



WD725CR  
8 053300 576456



WD725RO *New*  
8 055035 680095



WD725SEN  
8 053300 576470



WD725V  
8 053300 576494

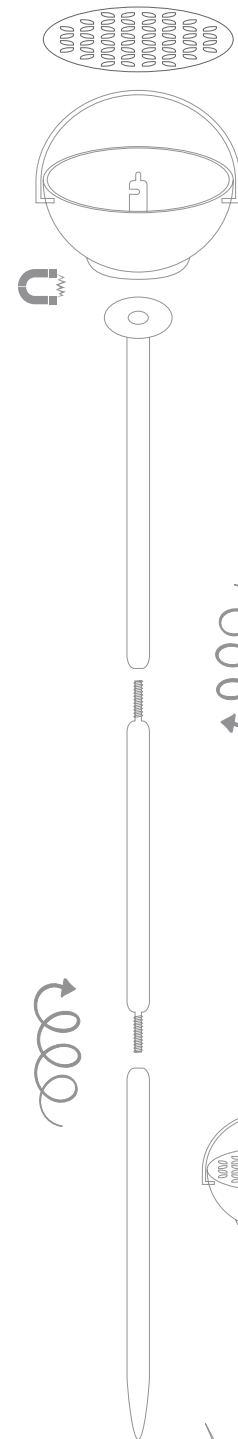

*Stelo modulare*  
*Adjustable stem*  
*Réglable tige*

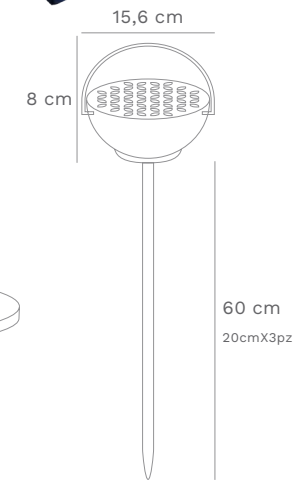

Lavare con un panno umido  
Wash with a damp cloth  
Nettoyer avec un chiffon humide



### WD798

**IT Cesto da picnic in vimini verde per 4 persone.** Decorato con tessuto a righe verdi e bianche, comodo e pratico. Contiene 4 piatti in ceramica; 4 forchette, 4 coltelli, 4 cucchiaini, 1 cavatappi in acciaio inox; 4 calici in vetro.

**EN White wicker picnic basket for 4 people.** Decorated with green and white striped fabric, comfortable and practical thanks to its adjustable shoulder strap. Contains 4 ceramic plates; 4 forks, 4 knives, 4 spoons, 1 stainless steel corkscrew; 4 glass tumblers.

**FR Panier de pique-nique en osier blanc pour 4 personnes.** Décoré avec un tissu à rayures vertes et blanches, confortable et pratique grâce à sa bandoulière réglable. Contient 4 assiettes en céramique; 4 fourchettes, 4 couteaux, 4 cuillères, 1 tire-bouchon en acier inoxydable; 4 verres.

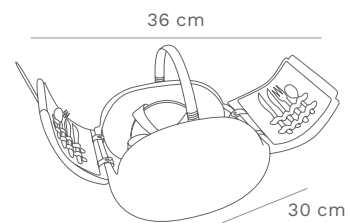

37 cm

30 cm



Lavare con un panno umido  
Wash with a damp cloth  
Nettoyer avec un chiffon humide



### WD730

**IT Borsa termica in vimini bianco.** Capiente e originale, perfetta per mantenere al fresco cibo e bevande durante le giornate fuori porta.

**EN Wicker cooler bag.** Spacious and unique, perfect for keeping food and drinks cool during outdoor outings.

**FR Sac isotherme en osier.** Spacieux et original, parfait pour maintenir au frais les aliments et les boissons lors des sorties en plein air.

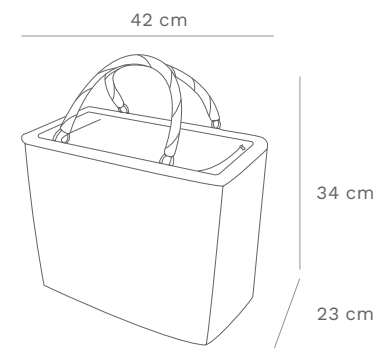

34 cm

23 cm



Lavare con un panno umido  
Wash with a damp cloth  
Nettoyer avec un chiffon humide



### WD731

**IT Cestino da picnic in vimini bianco per 2 persone.** Decorato con tessuto a righe multicolor, comodo e pratico grazie alla sua tracolla regolabile. Contiene 2 piatti in ceramica; 2 forchette, 2 coltelli, 2 cucchiaini, 1 cavatappi in acciaio inox; 2 calici in vetro; 1 borsa termica.

**EN White wicker picnic basket for 2 people.** Decorated with multicolored striped fabric, comfortable and practical thanks to its adjustable shoulder strap. Contains 2 ceramic plates; 2 forks, 2 knives, 2 spoons, 1 stainless steel corkscrew; 2 glass tumblers; 1 cooler bag.

**FR Panier de pique-nique en osier blanc pour 2 personnes.** Décoré avec un tissu à rayures multicolores, confortable et pratique grâce à sa bandoulière réglable. Contient 2 assiettes en céramique; 2 fourchettes, 2 couteaux, 2 cuillères, 1 tire-bouchon en acier inoxydable; 2 verres; 1 sac thermique.

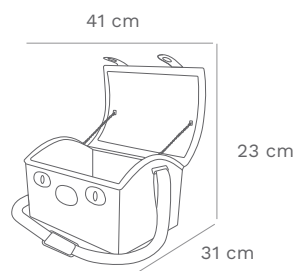

Lavare con un panno umido  
Wash with a damp cloth  
Nettoyer avec un chiffon humide

### WD732

**IT Cestino da picnic in vimini color miele per 2 persone.** Decorato con tessuto a righe multicolor, comodo e pratico. Contiene 2 piatti in ceramica; 2 forchette, 2 coltelli, 2 cucchiaini, 1 cavatappi in acciaio inox; 2 calici in vetro.

**EN Honey-colored wicker picnic basket for 2 people.** Decorated with multicolored striped fabric, comfortable and practical. Contains 2 ceramic plates; 2 forks, 2 knives, 2 spoons, 1 stainless steel corkscrew; 2 glass goblets.

**FR Panier de pique-nique en osier couleur miel pour 2 personnes.** Décoré avec un tissu à rayures multicolores, confortable et pratique. Contient 2 assiettes en céramique; 2 fourchettes, 2 couteaux, 2 cuillères, 1 tire-bouchon en acier inoxydable; 2 verres.

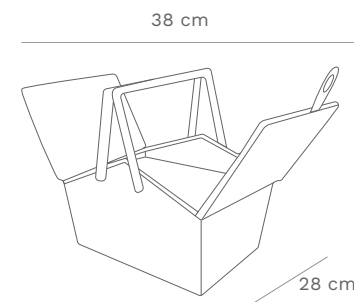

Lavare con un panno umido  
Wash with a damp cloth  
Nettoyer avec un chiffon humide

## WD733

**IT Cestino da picnic in vimini bianco per 4 persone.** Decorato con tessuto a righe bianche e blu, comodo e pratico grazie alla sua tracolla regolabile. Contiene 4 piatti in ceramica; 4 forchette, 4 coltelli, 4 cucchiaini, 1 cavatappi in acciaio inox; 4 calici in vetro; 1 borsa termica; 1 tovaglia dal fondo impermeabile.

**EN White wicker picnic basket for 4 people.** Decorated with white and blue striped fabric, comfortable and practical with its adjustable shoulder strap. Contains 4 ceramic plates; 4 forks, 4 knives, 4 spoons, 1 stainless steel corkscrew; 4 glass goblets; 1 thermal bag; 1 tablecloth with a waterproof bottom.

**FR Panier de pique-nique en osier blanc pour 4 personnes.** Décoré avec un tissu à rayures blanches et bleu, confortable et pratique avec sa bandoulière réglable. Contient 4 assiettes en céramique; 4 fourchettes, 4 couteaux, 4 cuillères, 1 tire-bouchon en acier inoxydable; 4 verres; 1 sac thermique; 1 nappe avec un fond imperméable.

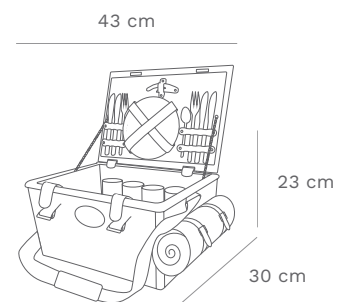

Lavare con un panno umido  
Wash with a damp cloth  
Nettoyer avec un chiffon humide





### WD734

**IT Cestino da picnic in vimini color miele per 4 persone.** Decorato con tessuto a righe multicolor, comodo e pratico. Contiene 4 piatti in ceramica; 4 forchette, 4 coltelli, 4 cucchiaini, 1 cavatappi in acciaio inox; 4 calici in vetro.

**EN Honey-colored wicker picnic basket for 4 people.** Decorated with multicolored striped fabric, comfortable and practical. Contains 4 ceramic plates; 4 forks, 4 knives, 4 spoons, 1 stainless steel corkscrew; 4 glass goblets.

**FR Panier de pique-nique en osier de couleur miel pour 4 personnes.** Décoré avec un tissu à rayures multicolores, confortable et pratique. Contient 4 assiettes en céramique; 4 fourchettes, 4 couteaux, 4 cuillères, 1 tire-bouchon en acier inoxydable; 4 verres en verre.



# MIAMI LINE



## WD821 *New*

1,2 L

**IT** Mug americana in acciaio inox 1,2 L. Comoda e pratica da portare sempre con te durante i tuoi allenamenti, i viaggi in auto, in ufficio o a scuola. La doppia funzionalità del tappo ti permette di sorseggiare le tue bevande sia con l'utilizzo della cannuccia, sia tramite il comodo beccuccio. Scovolino per cannuccia incluso.

**EN** American stainless steel mug 1.2 L. Convenient and practical to take with you during workouts, car trips, at the office, or school. The dual-function lid allows you to sip your drinks either using the straw or the comfortable spout. Straw cleaning brush included.

**FR** Mug américain en acier inoxydable 1,2 L. Pratique et facile à emporter avec vous lors de vos entraînements, voyages en voiture, au bureau ou à l'école. Le couvercle à double fonctionnalité vous permet de boire vos boissons soit avec la paille, soit par le bec pratique. Brosse de nettoyage pour la paille incluse.



WD821AZ  
8 055035 681016

WD821G  
8 055035 680972

WD821B  
8 055035 680705

WD821LI  
8 055035 680996

WD821CO  
8 055035 681009

WD821OL  
8 055035 680989

Ø 10 cm



27,5 cm



Lavare a mano  
Hand wash  
Lavage à la main

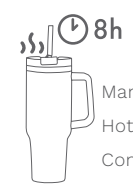

Mantiene fino a 8h di caldo  
Hot for up to 8h  
Conserve la chaleur jusqu'à 8 heures



Mantiene fino a 8h di freddo  
Cold for up to 8h  
Conserve le froid jusqu'à 8 heures



260 ml

## WD801 New

**IT** 0,26 L bottiglia termica in acciaio a doppia parete in diversi colori. Perfetta per portare sempre con te il caffè e le tue bevande preferite.

**EN** 0.26 L thermos stainless steel double wall bottle in different colors. Perfect for always carrying your coffee and your favourite drinks with you

**FR** Bouteille isotherme de 0,26 L en acier à double paroi, disponible en plusieurs couleurs. Idéal pour emporter partout votre café et vos boissons préférées.

Sottovuoto  
Vacuum  
Sous vide



Doppia camera  
Double wall  
Double paroi



Mantiene fino a 12h di caldo  
Hot for up to 12h  
Conserve la chaleur jusqu'à 12 heures



Mantiene fino a 24h di freddo  
Cold for up to 24h  
Conserve le froid jusqu'à 24 heures



INOX



WD801AR



WD801BL



WD801CA



WD801V



Ø 6 cm



20 cm



Lavare a mano  
Hand wash  
Lavage à la main



## WD506

**IT** 0,4 L bottiglia termica in acciaio a doppia parete in diversi colori e fantasie.

**EN** 0.4 L thermos stainless steel in stainless steel thermos in different colors and prints.

**FR** Bouteille isotherme de 0,4 L en acier à double paroi, disponible en plusieurs couleurs et motifs.

400 ml



WD506CAL



8 053300 572199



WD506LET



8 053300 572168



WD506SQU



8 053300 572182



WD506AR



8 033040 749358



WD506BL



8 033040 749365



WD506CO



8 033040 749389



WD506ME



8 033040 749372

Ø 7 cm



24 cm



Lavare a mano  
Hand wash  
Lavage à la main



**WD365**

**IT** 0,5L bottiglia termica in acciaio a doppia parete in diversi colori e decori.

**EN** 0,5L thermos stainless steel double wall bottle in different colors and decors.

**FR** Bouteille isotherme de 0,5L en acier à double paroi, disponible en plusieurs couleurs et décors.

500 ml

500 ml



WD365AR  
8 033040 743882



WD365AZ  
8 053300 571826



WD365B  
8 033040 743905



WD365BA  
8 053300 571833



WD365BL  
8 033040 744568



WD365CE  
8 033040 743899



WD365CO  
8 053300 571840



WD365F  
8 033040 744551



WD365G  
8 033040 743912



WD365GC  
8 053300 571857



WD365GI  
8 033040 747521



WD365LILLA  
8 033040 748139



WD365LIME  
8 033040 748085



WD365MAGENTA  
8 033040 748115



WD365MANDARINO  
8 033040 748108



WD365N  
8 033040 748092



WD365NOTTE  
8 033040 749341



WD365PETROLIO  
8 033040 748122



WD365R  
8 033040 747538



WD365RO  
8 053300 571864



WD365SA  
8 053300 571871



WD365SILVER  
8 033040 744575



WD365V  
8 033040 744544

Ø 7 cm

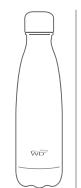

26 cm



Lavare a mano  
Hand wash  
Lavage à la main

500 ml



WD365APE WD365ARA WD365BEA WD365COS WD365FIO WD365FRU WD365GIR WD365JUNGLE



WD365MAIO WD365MANDALA WD365MESSICO WD365PAP WD365PAVONE WD365PES WD365TAT





500 ml



WD365CAN2 *New*  
8 055035 680361



WD365GAT2 *New*  
8 055035 680378



WD365KOA *New*  
8 055035 680392



WD365PAN *New*  
8 055035 680385

**WD474**

**IT** Bottiglia termica da 0,75L in acciaio a doppia parete in diversi colori.

**EN** Thermos 0,75L in stainless steel thermos in different colors.

**FR** Bouteille isotherme de 0,75L en acier à double paroi, disponible en plusieurs couleurs.

750 ml

**WD575**

**IT** Bottiglia termica da 1L in acciaio a doppia parete in diversi colori.

**EN** Thermos 1L in stainless steel thermos in different colors.

**FR** Bouteille isotherme de 1L en acier à double paroi, disponible en plusieurs couleurs.

1 litro



WD474B



8 033040 746524



WD474BL



8 033040 748344



WD474G



8 053300 573776



WD474GI



8 053300 573783



WD474MAT



8 053300 570300



WD575ANT



8 053300 572229



WD575AZ



8 053300 570287



WD575CO



8 053300 573806



WD474N



8 033040 746548



WD474OL



8 053300 570294



WD474PET



8 053300 570317



WD474R



8 033040 748351



WD575LIL



8 053300 572212



WD575TER



8 053300 572205



WD575V



8 053300 573790

Ø 8 cm

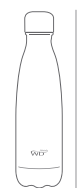

31 cm



Lavare a mano  
Hand wash  
Lavage à la main

Ø 8,5 cm



32 cm



Lavare a mano  
Hand wash  
Lavage à la main

## WD365KIT

**IT** Set per Bottiglia termica WD365 e WD506.

Il kit è composto da:

- Scovolino in fibra naturale e manico in legno ideale per pulire internamente la tua bottiglia;
- Tappo sport & leisure con cannuccia per le tue attività sportive;
- Gancio universale con moschettone per appendere la tua bottiglietta allo zaino, alla cintura o alla tua borsa;

**EN** Set for thermos bottle WD365 and WD506. The kit is composed of:

- Brush in natural fiber and wooden handle, ideal for cleaning your bottle internally;
- Sport & leisure top/lid with straw for your sports activities;
- Universal hook with snap hook to hang your bottle on your backpack, belt or any other bag;

**FR** Le kit se compose de:

- Brosse en fibres naturelles et manche en bois idéale pour nettoyer l'intérieur de votre bouteille;
- Bouchon sport & loisirs avec paille pour vos activités sportives;
- Mousqueton universel avec mousqueton pour accrocher votre bouteille à votre sac à dos, votre ceinture ou votre sac;

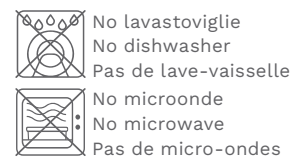

## WD550

**IT** Tappo smart. Con un tocco sul display, comparirà la temperatura della bevanda contenuta all'interno della tua bottiglia. La temperatura potrà essere facilmente controllata anche attraverso il colore della goccia presente sul display. Durata batteria circa 2 anni (o 50.000 visualizzazioni).

**EN** Smart lid. With a simple tap, the temperature of the drink in your bottle will appear on the display. The temperature can be also easily checked through the color of the drop on the display. Battery life approximately 2 years (or 50,000 views).

**FR** Bouchon intelligent. D'une simple pression sur l'écran, la température de la boisson contenue dans votre bouteille s'affiche. La température peut également être facilement contrôlée par la couleur de la goutte sur l'écran. Durée de vie des piles: environ 2 ans (ou 50 000 affichages).



Compatibile solo con WD365 e WD506  
Compatible only with WD365 and WD506  
Compatible uniquement avec WD365 et WD506

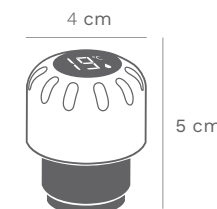
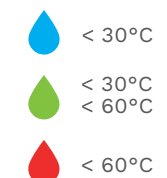

## WD518

**IT** Moschettone con anello in silicone colorato. Display da banco da 50 pz. Colori assortiti.

**EN** Snap hook with colored silicone ring. Display with 50 pcs. Assorted colors.

**FR** Mousqueton avec anneau en silicone coloré. Présentoir avec 50 pcs. Couleurs assorties.





### WD569

**IT Set composto da sei coperchi salvafreschezza in silicone.** Perfetto come coperchio per contenitori e per conservare i tuoi cibi. Conserva i tuoi cibi e le tue bevande, utilizzali come cover per barattoli, contenitori di vetro, frutta e verdura. Grazie alla loro eccellente flessibilità sono adattabili a varie misure e forme. Facili da pulire, poiché lavabili in lavastoviglie. Riutilizzali quante volte vuoi e aiuta il pianeta riducendo l'utilizzo delle pellicole plastiche.

**EN Set composed by six food silicone caps.** Perfect as a lid for containers and for storing your food. Store your food and drinks, use them as covers for jars, glass containers, fruit and vegetables. Thanks to their excellent flexibility they are adoptable to various sizes and shapes. Easy to clean, as they are dishwasher safe. Reuse them as many times as you want and help the environment by reducing the use of plastic films.

**FR Lot de six couvercles de conservation silicone.** Parfait comme couvercle pour les récipients. S'adapte à différentes tailles et formes. Facile à nettoyer, car lavable au lave-vaisselle. Réutilisable et aide à limiter l'utilisation de films plastiques.



WD569  
8°053300°570201

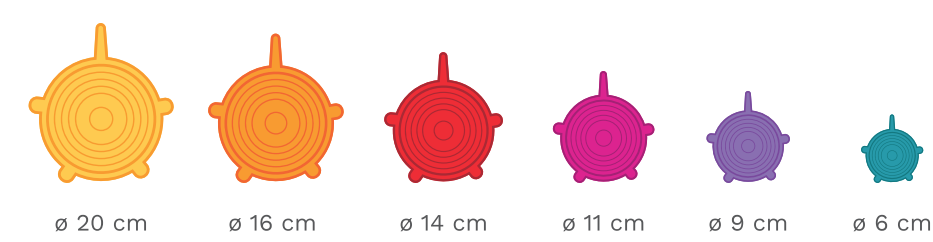

 Si lavastoviglie  
Dishwasher safe  
Lave-vaisselle possible

 Si microonde  
Microwave safe  
Micro-ondes possible

 No pellicola  
No film  
Pas de pellicule

 Impermeabile  
Waterproof  
Étanche

 Elastico  
Elastic  
Élastique

 Sigilla  
Seal  
Scellant

# MONTEREY LINE



## WD775 *New*

**IT** Caraffa in vetro borosilicato con decoro in vetro colorato all'interno. Ogni soggetto è realizzato artigianalmente in vetro soffiato rendendo ogni singola caraffa un pezzo unico. Capacità: 1,5 L.

**EN** Jug in borosilicate glass internally decored with a colored glass. Each design is handcrafted from blown glass, making each item a unique piece. Capacity: 1.5 L.

**FR** Carafe en verre borosilicate avec décor en verre coloré à l'intérieur. Chaque décor est réalisé artisanalement en verre soufflé, rendant chaque article unique. Contenance: 1,5 L.



WD775DEL  
8 053300 579075



WD775POL  
8 053300 579082



WD775CAN  
8 053300 579099



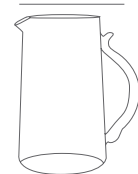

WD775GAT  
8 053300 579105

Ø 11,5 cm



20 cm

-  Sì lavastoviglie  
Dishwasher safe  
Lave-vaisselle possible
-  Sì microonde  
Microwave safe  
Micro-ondes possible

## WD776 *New*

**IT** Barattolo per miele con decori in vetro. Ogni soggetto è realizzato artigianalmente in vetro soffiato rendendo ogni singolo articolo un pezzo unico. Capacità 500 ml.

**EN** Honey jar with glass decorations. Each design is handcrafted from blown glass, making each item a unique piece. Capacity: 500 ml.

**FR** Pot à miel avec décors en verre. Chaque décor est réalisé artisanalement en verre soufflé, rendant chaque article unique. Contenance : 500 ml.



8 053300 579112

Ø 10 cm



14 cm



Sì lavastoviglie  
Dishwasher safe  
Lave-vaisselle possible



Sì microonde  
Microwave safe  
Micro-ondes possible



## WD777, WD778, WD779 *New*

**IT Barattolo con decoro in vetro.** Ogni soggetto è realizzato artigianalmente in vetro soffiato rendendo ogni singolo articolo un pezzo unico.

**EN Jar with glass decoration.** Each figure is handcrafted in blown glass, making each item a unique piece.

**FR Pot avec décoration en verre.** Chaque figurine est réalisée artisanalement en verre soufflé, rendant chaque pièce unique.



WD777CAR  
8 053300 579129



WD779CAF  
8 053300 579143



WD778BIS  
8 053300 579136

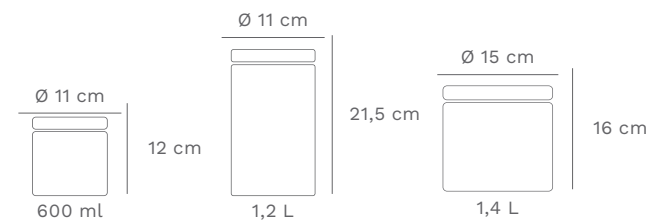

-  Si lavastoviglie  
Dishwasher safe  
Lave-vaisselle possible
-  Si microonde  
Microwave safe  
Micro-ondes possible

## WD717

**IT Set 2 tazzine in vetro borosilicato con manico colorato e decoro esterno in vetro colorato.** Ogni soggetto è realizzato artigianalmente in vetro soffiato rendendo ogni singolo articolo un pezzo unico. Capacità 130 ml.

**EN Set of 2 borosilicate glass cups with colored handle and external decoration in colored glass.** Each design is handcrafted in blown glass, making each individual item a unique piece. 130 ml capacity.

**FR Set de 2 tasses à café en verre borosilicate avec poignée colorée et décoration extérieure en verre coloré.** Chaque motif est fabriqué à la main en verre soufflé, ce qui rend chaque article unique. Capacité de 130 ml.



WD717APE  
8 053300 576166



WD717COC  
8 053300 576173



WD717LIB  
8 053300 576135



WD717LUM  
8 053300 576142



WD717FAR  
8 053300 576159



WD717MAR  
8 053300 576180

6 cm

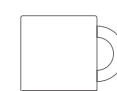

6 cm



Si lavastoviglie  
Dishwasher safe  
Lave-vaisselle possible



Si microonde  
Microwave safe  
Micro-ondes possible



### WD716

**IT** Zuccheriera in vetro borosilicato con cucchiaino e decori in vetro colorato. Ogni soggetto è realizzato artigianalmente in vetro soffiato rendendo ogni singolo articolo un pezzo unico. Capacità 300 ml.

**EN** Sugar bowl in borosilicate glass with teaspoon and decorations in colored glass. Each subject is handcrafted in blown glass making every single item a unique piece. 300 ml capacity.

**FR** Sucrier en verre borosilicate avec cuillère et décor en verre coloré. Chaque sujet est fabriqué à la main en verre soufflé faisant de chaque article une pièce unique. Contenance 300 ml.



WD716APE





8 053300 576111

WD716CON

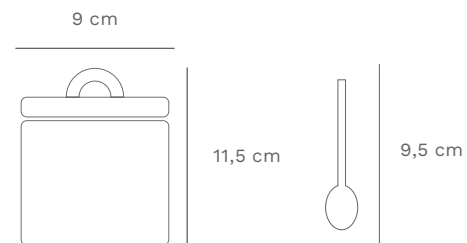

8 053300 576128



-  Sì lavastoviglie  
Dishwasher safe  
Lave-vaisselle possible
-  Sì microonde  
Microwave safe  
Micro-ondes possible

### WD695

**IT** Set 4 cucchiaini da caffè con decoro estivo realizzato artigianalmente in vetro soffiato colorato. Un regalo originale che farà impazzire amici e familiari, abbinalo agli altri articoli della linea Monterey per un set completo!

**EN** Set of 4 coffee spoons with summer decoration, handcrafted in coloured blown glass. An original gift that will delight friends and family, combine it with the other items in the Monterey line for a complete set!

**FR** Set de 4 cuillères à café avec décoration d'été, fabriquées artisanalement en verre soufflé coloré. Un cadeau original qui fera plaisir à vos amis et à votre famille. Combinez-le avec les autres articles de la ligne Monterey pour un ensemble complet!

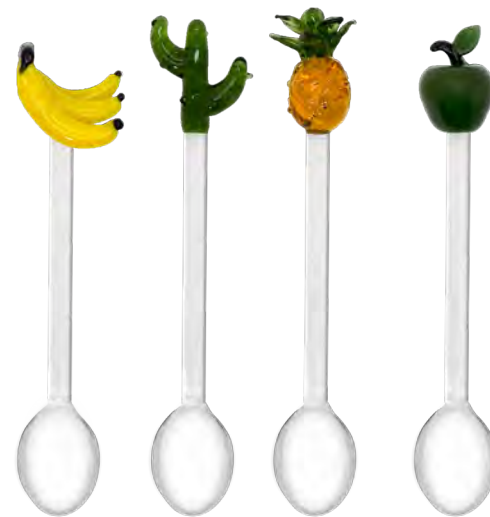

WD695AZZ



8 053300 576104





WD695ROS

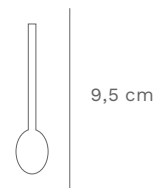

8 053300 576098



-  Sì lavastoviglie  
Dishwasher safe  
Lave-vaisselle possible
-  Sì microonde  
Microwave safe  
Micro-ondes possible

## WD566

**IT** Bicchieri in vetro borosilicato con soggetto in vetro colorato all'interno. Ogni soggetto è realizzato artigianalmente in vetro soffiato rendendo ogni singolo bicchiere un pezzo unico. Capacità: 250 ml.

**EN** Borosilicate glass tumblers with figure in coloured glass on the inside. Each figure is handcrafted in blown glass, making each glass a unique piece. Capacity: 250 ml.

**FR** Verres en verre borosilicate avec un sujet en verre coloré à l'intérieur. Chaque sujet est fabriqué à la main en verre soufflé, ce qui fait de chaque verre une pièce unique. Contenance: 250 ml.



WD566PFA

*New*



8 055035 680569



WD566PFU

*New*



8 055035 680576



WD566PRA

*New*



8 055035 680552



WD566PTO

*New*



8 055035 680545

Ø 8 cm



8 cm



Sì lavastoviglie  
Dishwasher safe  
Lave-vaisselle possible



Sì microonde  
Microwave safe  
Micro-ondes possible



## WD566

**IT** Bicchieri in vetro borosilicato con soggetto in vetro colorato all'interno. Ogni soggetto è realizzato artigianalmente in vetro soffiato rendendo ogni singolo bicchiere un pezzo unico. Capacità: 250 ml.

**EN** Borosilicate glass tumblers with figure in coloured glass on the inside. Each figure is handcrafted in blown glass, making each glass a unique piece. Capacity: 250 ml.

**FR** Verres en verre borosilicate avec un sujet en verre coloré à l'intérieur. Chaque sujet est fabriqué à la main en verre soufflé, ce qui fait de chaque verre une pièce unique. Contenance: 250 ml.



WD566AZZ *New*  
8 053300 579464



WD566BAL *New*  
8 053300 579419



WD566CAR *New*  
8 053300 579426



WD566ORO *New*  
8 053300 579440



WD566PAG *New*  
8 053300 579457



WD566TON *New*  
8 053300 579433



WD566CAV  
8 053300 570119



WD566COR  
8 053300 570096



WD566DEL  
8 053300 575978



WD566GRA  
8 053300 570089



WD566MED  
8 053300 570041



WD566POL  
8 053300 570058



WD566SQU  
8 053300 575985



WD566STE  
8 053300 570102

Ø 8 cm



8 cm



Sì lavastoviglie  
Dishwasher safe  
Lave-vaisselle possible



Sì microonde  
Microwave safe  
Micro-ondes possible



### WD566

**IT** Bicchieri in vetro borosilicato con soggetto in vetro colorato all'interno. Ogni soggetto è realizzato artigianalmente in vetro soffiato rendendo ogni singolo bicchiere un pezzo unico. Capacità: 250 ml.

**EN** Borosilicate glass tumblers with figure in coloured glass on the inside. Each figure is handcrafted in blown glass, making each glass a unique piece. Capacity: 250 ml.

**FR** Verres en verre borosilicate avec un sujet en verre coloré à l'intérieur. Chaque sujet est fabriqué à la main en verre soufflé, ce qui fait de chaque verre une pièce unique. Contenance: 250 ml.



WD566ORA  
8 053300 576074



WD566ORR  
8 053300 576067



WD566BLU *New*  
8 055035 680590



WD566ROS *New*  
8 055035 680583



Si lavastoviglie  
Dishwasher safe  
Lave-vaisselle possible

Si microonde  
Microwave safe  
Micro-ondes possible

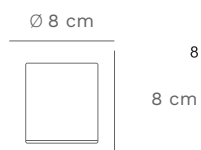

### WD566

**IT** Bicchieri in vetro borosilicato con soggetto in vetro colorato all'interno. Ogni soggetto è realizzato artigianalmente in vetro soffiato rendendo ogni singolo bicchiere un pezzo unico. Capacità: 250 ml.

**EN** Borosilicate glass tumblers with figure in coloured glass on the inside. Each figure is handcrafted in blown glass, making each glass a unique piece. Capacity: 250 ml.

**FR** Verres en verre borosilicate avec un sujet en verre coloré à l'intérieur. Chaque sujet est fabriqué à la main en verre soufflé, ce qui fait de chaque verre une pièce unique. Contenance: 250 ml.



WD566ALL  
8 053300 574933



WD566GEC  
8 053300 575954



WD566KOA  
8 053300 574964



WD566PAN  
8 053300 574940



WD566PEC  
8 053300 574919



WD566PEL  
8 053300 574957



WD566RIN  
8 053300 575961



WD566TUC  
8 053300 574926



WD566SCI *New*  
8 055035 680521

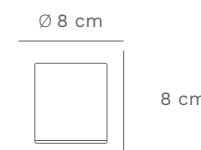

Si lavastoviglie  
Dishwasher safe  
Lave-vaisselle possible

Si microonde  
Microwave safe  
Micro-ondes possible

### WD566

**IT Bicchieri in vetro borosilicato con soggetto in vetro colorato all'interno.** Ogni soggetto è realizzato artigianalmente in vetro soffiato rendendo ogni singolo bicchiere un pezzo unico. Capacità: 250 ml.

**EN Borosilicate glass tumblers with figure in coloured glass on the inside.** Each figure is handcrafted in blown glass, making each glass a unique piece. Capacity: 250 ml.

**FR Verres en verre borosilicate avec un sujet en verre coloré à l'intérieur.** Chaque sujet est fabriqué à la main en verre soufflé, ce qui fait de chaque verre une pièce unique. Contenance: 250 ml.



WD566APE  
8 053300 572052



WD566COC  
8 053300 571130



WD566CONI  
8 053300 572045



WD566ELE  
8 053300 571147



WD566FAR  
8 053300 572021



WD566FEN  
8 053300 570072



WD566FUN  
8 053300 572878



WD566GAB  
8 053300 575992



WD566PIN  
8 055035 680538

*New*



WD566GAL  
8 053300 571154



WD566GIR  
8 053300 572069



WD566GUF  
8 053300 571161



WD566MAR  
8 053300 572076



WD566PAP  
8 053300 571178



WD566PAPE  
8 053300 571185



WD566RAN  
8 053300 570065



WD566TAR  
8 053300 570133



WD566TUL  
8 053300 572038



WD566UVA  
8 053300 572854



WD566VOL  
8 053300 572885



WD566ZUC  
8 053300 572861

Ø 8 cm



8 cm



Sì lavastoviglie  
Dishwasher safe  
Lave-vaisselle possible



Sì microonde  
Microwave safe  
Micro-ondes possible

## WD566

**IT** Bicchieri in vetro borosilicato con soggetto in vetro colorato all'interno. Ogni soggetto è realizzato artigianalmente in vetro soffiato rendendo ogni singolo bicchiere un pezzo unico. Capacità: 250 ml.

**EN** Borosilicate glass tumblers with figure in coloured glass on the inside. Each figure is handcrafted in blown glass, making each glass a unique piece. Capacity: 250 ml.

**FR** Verres en verre borosilicate avec un sujet en verre coloré à l'intérieur. Chaque sujet est fabriqué à la main en verre soufflé, ce qui fait de chaque verre une pièce unique. Contenance: 250 ml.



WD566PEP



8 053300 576043



WD566OUA



8 053300 576036



WD566SAC



8 053300 576029



WD566MAN



8 053300 576050



Ø 8 cm

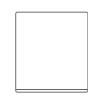

8 cm



Sì lavastoviglie  
Dishwasher safe  
Lave-vaisselle possible



Sì microonde  
Microwave safe  
Micro-ondes possible



## WD566

**IT** Bicchieri in vetro borosilicato con soggetto in vetro colorato all'interno. Ogni soggetto è realizzato artigianalmente in vetro soffiato rendendo ogni singolo bicchiere un pezzo unico. Capacità: 250 ml.

**EN** Borosilicate glass tumblers with figure in coloured glass on the inside. Each figure is handcrafted in blown glass, making each glass a unique piece. Capacity: 250 ml.

**FR** Verres en verre borosilicate avec un sujet en verre coloré à l'intérieur. Chaque sujet est fabriqué à la main en verre soufflé, ce qui fait de chaque verre une pièce unique. Contenance: 250 ml.



WD566BAS



8 053300 577293



WD566CAN



8 053300 576005



WD566GAT



8 053300 576012



WD566SIA



8 053300 577286



Ø 8 cm

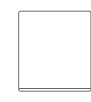

8 cm



Sì lavastoviglie  
Dishwasher safe  
Lave-vaisselle possible



Sì microonde  
Microwave safe  
Micro-ondes possible



### WD566

**IT** Bicchieri in vetro borosilicato con soggetto in vetro colorato all'interno. Ogni soggetto è realizzato artigianalmente in vetro soffiato rendendo ogni singolo bicchiere un pezzo unico. Capacità: 250 ml.

**EN** Borosilicate glass tumblers with figure in coloured glass on the inside. Each figure is handcrafted in blown glass, making each glass a unique piece. Capacity: 250 ml.

**FR** Verres en verre borosilicate avec un sujet en verre coloré à l'intérieur. Chaque sujet est fabriqué à la main en verre soufflé, ce qui fait de chaque verre une pièce unique. Contenance: 250 ml.



WD566ASI



8 053300 577309



WD566MAI



8 053300 577316



WD566MUC



8 053300 577323



WD566TOR



8 053300 577330



Ø 8 cm

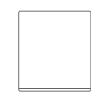

8 cm



Si lavastoviglie  
Dishwasher safe  
Lave-vaisselle possible



Si microonde  
Microwave safe  
Micro-ondes possible

### WD566

**IT** Bicchieri in vetro borosilicato con soggetto in vetro colorato all'interno. Ogni soggetto è realizzato artigianalmente in vetro soffiato rendendo ogni singolo bicchiere un pezzo unico. Capacità: 250 ml.

**EN** Borosilicate glass tumblers with figure in coloured glass on the inside. Each figure is handcrafted in blown glass, making each glass a unique piece. Capacity: 250 ml.

**FR** Verres en verre borosilicate avec un sujet en verre coloré à l'intérieur. Chaque sujet est fabriqué à la main en verre soufflé, ce qui fait de chaque verre une pièce unique. Contenance: 250 ml.



WD566CIG



8 053300 577262



WD566COL



8 053300 577279

Ø 8 cm

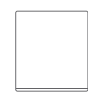

8 cm



Si lavastoviglie  
Dishwasher safe  
Lave-vaisselle possible



Si microonde  
Microwave safe  
Micro-ondes possible



### WD566

**IT** Bicchieri in vetro borosilicato con soggetto in vetro colorato all'interno. Ogni soggetto è realizzato artigianalmente in vetro soffiato rendendo ogni singolo bicchiere un pezzo unico. Capacità: 250 ml.

**EN** Borosilicate glass tumblers with figure in coloured glass on the inside. Each figure is handcrafted in blown glass, making each glass a unique piece. Capacity: 250 ml.

**FR** Verres en verre borosilicate avec un sujet en verre coloré à l'intérieur. Chaque sujet est fabriqué à la main en verre soufflé, ce qui fait de chaque verre une pièce unique. Contenance: 250 ml.



WD566ARA  
8 053300 573325



WD566FRA  
8 053300 573332



WD566LIM  
8 053300 573318



WD566MEL  
8 053300 573349



Ø 8 cm



8 cm



Sì lavastoviglie  
Dishwasher safe  
Lave-vaisselle possible



Sì microonde  
Microwave safe  
Micro-ondes possible

### WD566

**IT** Bicchieri in vetro borosilicato con soggetto in vetro colorato all'interno. Ogni soggetto è realizzato artigianalmente in vetro soffiato rendendo ogni singolo bicchiere un pezzo unico. Capacità: 250 ml.

**EN** Borosilicate glass tumblers with figure in coloured glass on the inside. Each figure is handcrafted in blown glass, making each glass a unique piece. Capacity: 250 ml.

**FR** Verres en verre borosilicate avec un sujet en verre coloré à l'intérieur. Chaque sujet est fabriqué à la main en verre soufflé, ce qui fait de chaque verre une pièce unique. Contenance: 250 ml.



WD566BOR  
8 053300 573295



WD566CUO  
8 053300 573301



WD566LUC  
8 053300 573288



WD566SCA  
8 053300 573271



Ø 8 cm



8 cm



Sì lavastoviglie  
Dishwasher safe  
Lave-vaisselle possible



Sì microonde  
Microwave safe  
Micro-ondes possible

### WD585

**IT** Bottiglia in vetro borosilicato con tappo con chiusura ermetica e decoro in vetro colorato all'interno. Soggetto realizzato artigianalmente in vetro soffiato, ogni singola bottiglia è un pezzo unico. Capacità: 1,2L.

**EN** Bottle in borosilicate glass with watertight lid and a decoration in colored glass inside. Element handcrafted in blown glass, each bottle is a unique piece. Capacity: 1,2L.

**FR** Bouteille en verre borosilicate avec décoration en verre coloré à l'intérieur. Fabriquée à la main en verre soufflé, chaque bouteille est une pièce unique. Capacité: 1,2L.



WD585ANC



8 053300 571307

WD585FOC



8 053300 576081

WD585ANG



8 053300 573356

WD585ORO



8 053300 579471

Ø 8,5 cm

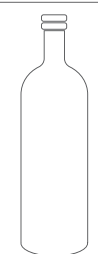

30 cm



Sì lavastoviglie  
Dishwasher safe  
Lave-vaisselle possible



Sì microonde  
Microwave safe  
Micro-ondes possible

### WD565

**IT** Brocca in vetro borosilicato con soggetto in vetro colorato all'interno. Ogni soggetto è realizzato artigianalmente in vetro soffiato rendendo ogni singola brocca un pezzo unico. Capacità: 1,7L.

**EN** Pitcher in borosilicate glass internally decorated with a element in colored glass. Each inside element is handcrafted in blown glass, making every single pitcher a unique piece. Capacity: 1,7L.

**FR** Pichet en verre borosilicate avec figurine en verre à l'intérieur. Fabriquée à la main en verre soufflé, chaque bouteille est une pièce unique. Contenance: 1,7L.



WD565CII



8 053300 573394

WD565CUO



8 053300 571208

WD565NIN



8 053300 572236

Ø 18,5 cm

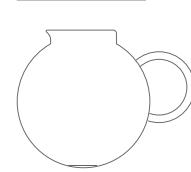

17,5 cm



Sì lavastoviglie  
Dishwasher safe  
Lave-vaisselle possible



Sì microonde  
Microwave safe  
Micro-ondes possible

WD565PES



8 053300 570027

**WD564**

**IT Caraffa in vetro borosilicato con decoro in vetro colorato all'interno.** Ogni soggetto è realizzato artigianalmente in vetro soffiato rendendo ogni singola caraffa un pezzo unico. Capacità: 1,2L.

**EN Carafe in borosilicate glass with a decoration in colored glass inside.** Each figure is handcrafted in blown glass making every single pitcher a unique piece. Capacity: 1,2L

**FR Carafe en verre borosilicate avec décoration en verre coloré à l'intérieur.** Chaque sujet est fabriqué à la main en verre soufflé, ce qui fait de chaque carafe une pièce unique. Contenance: 1,2L.



WD564FEN



8 053300 577347

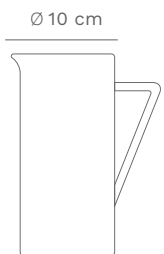

20 cm



Si lavastoviglie  
Dishwasher safe  
Lave-vaisselle possible



Si microonde  
Microwave safe  
Micro-ondes possible



WD564ARA



8 053300 573387



WD564BAL



8 053300 570010



WD564SOT



8 053300 570003



WD564OJA



8 053300 571192



**WD709**

**IT Teiera in vetro borosilicato con filtro in vetro.** La particolarità del manico e del decoro sul tappo rendono la teiera Monterey un articolo di design originale e d'effetto. Capacità: 800ml.

**EN Borosilicate glass teapot with glass filter.** The special handle and decoration on the stopper make the Monterey teapot an original and impressive design article. Capacity: 800ml.

**FR Théière en verre borosilicate avec filtre en verre.** La poignée spéciale et la décoration du bouchon font de la théière Monterey un article de design original et impressionnant. Contenance: 800ml.



WD709BL  
8 053300 575565



WD709G  
8 053300 575541



WD709V  
8 053300 575558



-  No lavastoviglie  
No dishwasher  
Pas de lave-vaisselle
-  No microonde  
No microwave  
Pas de micro-ondes





### WD633

**IT** Tazza in vetro borosilicato con decoro in vetro colorato all'interno. Ogni soggetto è realizzato artigianalmente in vetro soffiato rendendo ogni singola tazza un pezzo unico. Capacità: 420ml.

**EN** Borosilicate glass mug with colored glass subject inside. Each subject is handcrafted in blown glass making each cup a unique piece. Capacity: 420ml.

**FR** Tasse en verre borosilicate avec décoration en verre coloré à l'intérieur. Chaque sujet est fabriqué à la main en verre soufflé, ce qui fait de chaque tasse une pièce unique. Contenance: 420ml.



WD633BIS  
8 053300 577378



WD633BRI  
8 053300 577354



WD633MAC  
8 053300 577361



WD633CUP  
8 053300 573363



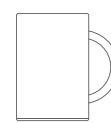

WD633TOR  
8 053300 573370

Ø 8 cm



11 cm

-  Sì lavastoviglie  
Dishwasher safe  
Lave-vaisselle possible
-  Sì microonde  
Microwave safe  
Micro-ondes possible



## WD633

**IT Tazza in vetro borosilicato con decoro in vetro colorato all'interno.** Ogni soggetto è realizzato artigianalmente in vetro soffiato rendendo ogni singola tazza un pezzo unico. Capacità: 420ml.

**EN Borosilicate glass mug with colored glass subject inside.** Each subject is handcrafted in blown glass making each cup a unique piece. Capacity: 420ml.

**FR Tasse en verre borosilicate avec décoration en verre coloré à l'intérieur.** Chaque sujet est fabriqué à la main en verre soufflé, ce qui fait de chaque tasse une pièce unique. Contenance: 420ml.



WD633CAN  
8 053300 572809



WD633CER  
8 053300 572830



WD633GAT  
8 053300 572816



WD633SCO  
8 053300 572823



Ø 8 cm

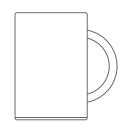

11 cm



Si lavastoviglie  
Dishwasher safe  
Lave-vaisselle possible



Si microonde  
Microwave safe  
Micro-ondes possible



**WD645**

**IT Acetiera in vetro borosilicato con decoro grappolo d'uva in vetro colorato all'interno.** Beccuccio anti-goccia per dosare correttamente l'aceto nelle tue pietanze. Grazie alle proprietà del vetro borosilicato è molto resistente ed allo stesso tempo particolarmente trasparente e leggera. Capacità 250ml.

**EN Vinegar jug made of borosilicate glass with colored glass bunch of grapes decoration inside.** Anti-drip spout to properly dose the vinegar into your dishes. Thanks to the properties of borosilicate glass it is very resistant and at the same time particularly transparent and light. Capacity: 250ml.

**FR Vinaigrier en verre borosilicate avec décoration de grappe de raisins en verre coloré à l'intérieur.** Bec verseur anti-goutte pour doser correctement le vinaigre dans vos plats. Grâce aux propriétés du verre borosilicate, il est très résistant et en même temps particulièrement transparent et léger. Contenance 250ml.



Ø 8 cm



19 cm

-  Sì lavastoviglie  
Dishwasher safe  
Lave-vaisselle possible
-  Sì microonde  
Microwave safe  
Micro-ondes possible

WD645ACE



8 053300 577385

## WD644

**IT Oliera in vetro borosilicato con decoro olive in vetro colorato all'interno.** Beccuccio anti-goccia per dosare correttamente l'olio nelle tue pietanze. Grazie alle proprietà del vetro borosilicato è molto resistente ed allo stesso tempo particolarmente trasparente e leggera. Capacità 500ml.

**EN Oil jug made of borosilicate glass with colored glass olive decoration inside.** Anti-drip spout to properly dose the oil into your dishes. Thanks to the properties of borosilicate glass it is very resistant and at the same time particularly transparent and light. Capacity: 500ml.



**FR Huilier en verre borosilicate avec décoration d'olives en verre coloré à l'intérieur.** Bec verseur anti-goutte pour doser correctement l'huile dans vos plats. Grâce aux propriétés du verre borosilicate, il est très résistant et en même temps particulièrement transparent et léger. Contenance 500ml.

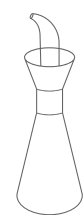

Ø 11 cm



19 cm

-  Si lavastoviglie  
Dishwasher safe  
Lave-vaisselle possible
-  Si microonde  
Microwave safe  
Micro-ondes possible

WD644OLI



8 053300 573400

## WD645

**IT Oliera in vetro borosilicato con decoro peperoncino in vetro colorato all'interno.** Beccuccio anti-goccia per dosare correttamente l'olio nelle tue pietanze. Grazie alle proprietà del vetro borosilicato è molto resistente ed allo stesso tempo particolarmente trasparente e leggera. Capacità 250ml.

**EN Oil jug made of borosilicate glass with colored glass chili pepper decoration inside.** Anti-drip spout to properly dose the oil into your dishes. Thanks to the properties of borosilicate glass it is very resistant and at the same time particularly transparent and light. Capacity: 250ml.

**FR Huilier en verre borosilicate avec décoration piment en verre coloré à l'intérieur.** Bec verseur anti-goutte pour doser correctement l'huile dans vos plats. Grâce aux propriétés du verre borosilicate, il est très résistant et en même temps particulièrement transparent et léger. Contenance 250ml.



Ø 8 cm

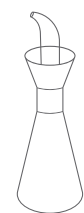

19 cm

-  Si lavastoviglie  
Dishwasher safe  
Lave-vaisselle possible
-  Si microonde  
Microwave safe  
Micro-ondes possible

WD645PEP



8 053300 573417

### WD710

**IT** Diffusore di essenza in vetro borosilicato con decoro in vetro colorato all'esterno e due set di bastoncini in legno (colore naturale e nero). Un oggetto che ti permette di rendere ogni ambiente particolare creando fragranze diverse a seconda dei tuoi gusti. Perfetto anche come regalo per amici e parenti. Oli essenziali non inclusi. Capacità: 230 ml.

**EN** Borosilicate glass essence diffuser with coloured glass decoration on the outside and two sets of wooden sticks (natural and black). An object that allows you to make every room special by creating different fragrances according to your taste. Also perfect as a gift for friends and family. Essential oils not included. Capacity: 230 ml.

**FR** Diffuseur d'essence en verre borosilicate avec décoration en verre coloré à l'extérieur et deux lots de bâtonnets en bois (naturel et noir). Un objet qui vous permet de rendre chaque pièce spéciale en créant des parfums différents selon votre goût. Idéal également comme cadeau pour les amis et la famille. Les huiles essentielles ne sont pas incluses. Contenance: 230 ml.



WD710COC  
8 053300 575589



WD710CUO  
8 053300 575572



WD710FAR  
8 053300 575022



Ø 6 cm



11,5 cm



Si lavastoviglie  
Dishwasher safe  
Lave-vaisselle possible

### WD636

**IT** Clessidra in vetro borosilicato con sabbia colorata e soggetto in vetro colorato all'interno. Durata: 30 min. Tenere in un luogo asciutto per evitare che la sabbia si addensi.

**EN** Hourglass in borosilicate glass with colored sand and colored glass subject inside. Duration: 30 min. Keep in a dry place to prevent sand from thickening.

**FR** Sablier en verre borosilicaté avec sable coloré et sujet en verre coloré à l'intérieur. Durée: 30 min. Conserver dans un endroit sec pour éviter que le sable ne s'épaississe.



WD636CAC  
8 053300 572977



WD636CAM  
8 053300 572991



WD636GIR  
8 053300 572984

Ø 8 cm



20 cm



Lavare con un panno umido  
Wash with a damp cloth  
Nettoyer avec un chiffon humide

**WD565**

**IT** Brocca in vetro borosilicato con decoro natalizio in vetro colorato all'interno. Ogni soggetto è realizzato artigianalmente in vetro soffiato rendendo ogni singola brocca un pezzo unico. Scegli il tuo drinking mood e sperimenta i vari abbinamenti ottenendo una tavola gioiosa e raffinata. Capacità: 1,7L.

**EN** Pitcher in borosilicate glass internally decorated with Christmas decoration in colored glass. Each inside element is handcrafted in blown glass, making every single pitcher a unique piece. Choose your drinking mood and experiment with the various combinations to create a joyful and refined table. Capacity: 1,7L.

**FR** Pichet en verre borosilicate avec décoration de Noël en verre à l'intérieur. Fabriqué à la main en verre soufflé, chaque pichet est une pièce unique. Choisissez votre drinking mood et expérimentez les différentes combinaisons pour obtenir une table joyeuse et raffinée. Contenance: 1,7L.



WD565PAN



8 053300 577408

Ø 18,5 cm

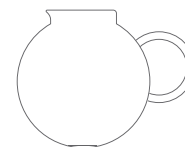

17,5 cm



Si lavastoviglie  
Dishwasher safe  
Lave-vaisselle possible



Si microonde  
Microwave safe  
Micro-ondes possible

WD565STAR



8 053300 572847

### WD564

**IT** Caraffa in vetro borosilicato con decoro natalizio in vetro colorato all'interno. Ogni soggetto è realizzato artigianalmente in vetro soffiato rendendo ogni singola caraffa un pezzo unico. Capacità: 1,2L.

**EN** Carafe in borosilicate glass with a Christmas decoration in colored glass inside. Each figure is handcrafted in blown glass making every single pitcher a unique piece. Capacity: 1,2L

**FR** Carafe en verre borosilicate avec décoration de Noël en verre coloré à l'intérieur. Chaque sujet est fabriqué à la main en verre soufflé, ce qui fait de chaque carafe une pièce unique. Contenance: 1,2L.

### WD585

**IT** Bottiglia in vetro borosilicato con tappo con chiusura ermetica e decoro natalizio in vetro colorato all'interno. Soggetto realizzato artigianalmente in vetro soffiato, ogni singola bottiglia è un pezzo unico. Capacità: 1,2L.

**EN** Bottle in borosilicate glass with watertight lid and a Christmas decoration in colored glass inside. Element handcrafted in blown glass, each bottle is a unique piece. Capacity: 1,2L.



**FR** Bouteille en verre borosilicate avec décoration de Noël en verre coloré à l'intérieur. Fabriquée à la main en verre soufflé, chaque bouteille est une pièce unique. Capacité: 1,2L.

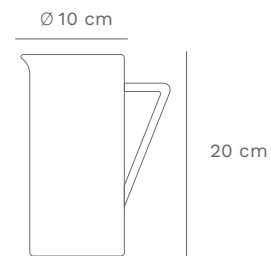

WD564ALB  
8 053300 572892

WD564PUP  
8 053300 575008



-  Sì lavastoviglie  
Dishwasher safe  
Lave-vaisselle possible
-  Sì microonde  
Microwave safe  
Micro-ondes possible



WD585SCH  
8 053300 577415

Ø 8,5 cm

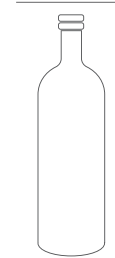

-  Sì lavastoviglie  
Dishwasher safe  
Lave-vaisselle possible
-  Sì microonde  
Microwave safe  
Micro-ondes possible

### WD633

**IT** Tazza in vetro borosilicato con decoro natalizio in vetro colorato all'interno. Ogni soggetto è realizzato artigianalmente in vetro soffiato rendendo ogni singola tazza un pezzo unico. Capacità: 420ml.

**EN** Borosilicate glass mug with Christmas colored glass subject inside. Each subject is handcrafted in blown glass making each cup a unique piece. Capacity: 420ml.

**FR** Tasse en verre borosilicate avec décoration de Noël en verre coloré à l'intérieur. Chaque sujet est fabriqué à la main en verre soufflé, ce qui fait de chaque tasse une pièce unique. Contenance: 420ml.



WD633ALB



8 053300 577507



WD633GHI



8 053300 577880



WD633PAN



8 053300 577873



WD633SCH



8 053300 577866

Ø 8 cm

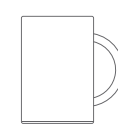

11 cm



Si lavastoviglie  
Dishwasher safe  
Lave-vaisselle possible



Si microonde  
Microwave safe  
Micro-ondes possible



### WD695

**IT** Set 4 cucchiaini da caffè con decoro natalizio realizzato artigianalmente in vetro soffiato colorato. Un regalo originale che farà impazzire amici e familiari, abbinalo agli altri articoli della linea Monterey per un set completo!

**EN** Set of 4 coffee spoons with Christmas decoration, handcrafted in coloured blown glass. An original gift that will delight friends and family, combine it with the other items in the Monterey line for a complete set!

**FR** Set de 4 cuillères à café avec décoration de Noël, fabriquées artisanalement en verre soufflé coloré. Un cadeau original qui fera plaisir à vos amis et à votre famille. Combinez-les avec les autres articles de la ligne Monterey pour un ensemble complet !



WD695NAT3



8 053300 577392



WD695NAT1



8 053300 574902



WD695NAT2



8 053300 575343



9,5 cm



Sì lavastoviglie  
Dishwasher safe  
Lave-vaisselle possible



Sì microonde  
Microwave safe  
Micro-ondes possible

### WD566

**IT** Bicchieri in vetro borosilicato con soggetto natalizio in vetro colorato all'interno. Ogni soggetto è realizzato artigianalmente in vetro soffiato rendendo ogni singolo bicchiere un pezzo unico. Capacità: 250 ml.

**EN** Borosilicate glass tumblers with a Christmas figure in coloured glass on the inside. Each figure is handcrafted in blown glass, making each glass a unique piece. Capacity: 250 ml

**FR** Verres en verre borosilicate avec un sujet de Noël en verre coloré à l'intérieur. Chaque sujet est fabriqué à la main en verre soufflé, ce qui fait de chaque verre une pièce unique. Contenance: 250 ml.



WD566NAT4



8 053300 577514



WD566NAT



8 053300 571291



WD566NAT3



8 053300 574971

Ø 8 cm



8 cm



Sì lavastoviglie  
Dishwasher safe  
Lave-vaisselle possible



Sì microonde  
Microwave safe  
Micro-ondes possible

## WD710

**IT** Diffusori per essenze in vetro borosilicato con decoro a tema natalizio. Sticks colore avana e nero inclusi. Oli essenziali non inclusi. Capacità: 230 ml.

**EN** Borosilicate glass essence diffuser with a Christmas figure in coloured glass on the inside. Havana and black sticks included. Essential oils not included. Capacity: 230 ml.

**FR** Diffuseur d'essence en verre borosilicate avec un sujet de Noël en verre coloré à l'intérieur. Les huiles essentielles ne sont pas incluses. Contenance: 230 ml.



WD710FIO



8 053300 577538



WD710GHI



8 053300 577521



Ø 6 cm



11,5 cm



Si lavastoviglie  
Dishwasher safe  
Lave-vaisselle possible



### WD624

**IT Set 2 bicchierini in vetro borosilicato doppia parete.** La parete interna è realizzata in vetro colorato mentre quella esterna in vetro trasparente. Ideali per servire caffè, grappe e liquori. Il vetro borosilicato sopporta le alte e basse temperature e la doppia parete le mantiene più a lungo. Capacità: 80ml.

**EN Set of 2 double-walled borosilicate glass cups.** The inner wall is made of coloured glass while the outer one is made of transparent glass. Ideal for serving coffee, grappa and liqueurs. Borosilicate glass withstands high and low temperatures, and the double wall keeps them longer. Capacity: 80ml.

**FR Ensemble de 2 gobelets double paroi en verre borosilicate.** La paroi intérieure est en verre coloré. Le gobelet double paroi permet de conserver la chaleur plus longtemps. Le verre borosilicate résiste aux températures élevées. Idéal pour les boissons chaudes ou fraîches. Contenance : 80ml.



WD624BL



8 053300 572250

WD624GI



8 053300 572243



WD624V



8 053300 572267



Ø 5,5 cm

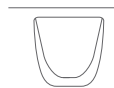

6,5 cm



Sì lavastoviglie  
Dishwasher safe  
Lave-vaisselle possible



Sì microonde  
Microwave safe  
Micro-ondes possible

### WD626

**IT Caraffa in vetro borosilicato doppia parete.** La parete interna è realizzata in vetro colorato mentre quella esterna in vetro trasparente. Ideale per servire bevande fresche o calde, grazie alle caratteristiche del vetro borosilicato che sopporta le alte e basse temperature. La doppia parete mantiene inoltre più a lungo la temperatura. Capacità: 800ml.

**EN Double wall borosilicate glass carafe.** The inner wall is made of coloured glass while the outer one is made of transparent glass. Ideal for serving cool or hot drinks, thanks to the characteristics of borosilicate glass that withstands high and low temperatures. The double wall also maintains the temperature longer. Capacity: 800ml.

**FR Pichet double paroi en verre borosilicate.** La paroi intérieure est en verre coloré. Le pichet double paroi permet de conserver la chaleur ou le frais plus longtemps. Le verre borosilicate résiste aux températures élevées. Idéal pour les boissons chaudes ou fraîches. Contenance : 800ml.



WD626BL



8 053300 572311

WD626GI



8 053300 572304

WD626V



8 053300 572328



Ø 10,5 cm

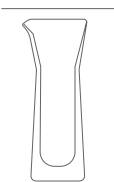

27 cm



Sì lavastoviglie  
Dishwasher safe  
Lave-vaisselle possible



Sì microonde  
Microwave safe  
Micro-ondes possible

## WD625

**IT Set 2 bicchieri in vetro borosilicato doppia parete.** La parete interna è realizzata in vetro colorato mentre quella esterna in vetro trasparente. Ideali per servire bevande fresche o calde, grazie alle caratteristiche del vetro borosilicato che sopporta le alte e basse temperature. La doppia parete mantiene inoltre più a lungo la temperatura. Capacità: 220ml.

**EN Set of 2 double wall borosilicate glass glasses.** The inner wall is made of coloured glass while the outer one is made of transparent glass. Ideal for serving cool or hot drinks, thanks to the characteristics of borosilicate glass that withstands high and low temperatures. The double wall also maintains the temperature longer. Capacity: 220ml.

**FR Ensemble de 2 verres double paroi en verre borosilicate.** La paroi intérieure est en verre coloré. Le gobelet double paroi permet de conserver la chaleur ou le frais plus longtemps. Le verre borosilicate résiste aux températures élevées. Idéal pour les boissons chaudes ou fraîches. Contenance : 220ml.



WD625BL



8°053300°572281



WD625GI



8°053300°572274



WD625V



8°053300°572298



Ø 7,5 cm



11 cm



Sì lavastoviglie  
Dishwasher safe  
Lave-vaisselle possible



Sì microonde  
Microwave safe  
Micro-ondes possible



**WD627**

**IT Set 2 ciotole in vetro borosilicato doppia parete.** La parete interna è realizzata in vetro colorato mentre quella esterna in vetro trasparente. Ideali per tiramisù, finger food, gelati, mousse o macedonia. Il vetro borosilicato sopporta le alte e basse temperature e la doppia parete le mantiene più a lungo. Capacità: 180ml.

**EN Set of 2 bowls in double wall borosilicate glass.** The inner wall is made of coloured glass while the outer one is made of transparent glass. Ideal for tiramisù, finger food, ice cream, mousse or fruit salad. Borosilicate glass withstands high and low temperatures, and the double wall keeps them longer. Capacity: 180ml.

**FR Set de 2 coupelles double paroi en verre borosilicate.** La paroi intérieure est en verre coloré. La coupelle double paroi permet de conserver la chaleur ou le frais plus longtemps. Le verre borosilicate résiste aux températures élevées. Idéal pour les boissons chaudes ou fraîches. Contenance : 180ml.



WD627BL  
8 053300 572342

WD627GI  
8 053300 572335



WD627V  
8 053300 572359

Ø 9,5 cm

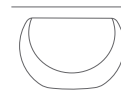

6 cm



Sì lavastoviglie  
Dishwasher safe  
Lave-vaisselle possible



Sì microonde  
Microwave safe  
Micro-ondes possible



## WD632

**IT Set di 2 flûte a doppia parete in vetro borosilicato.** La doppia parete mantiene il tuo champagne fresco più a lungo rispetto al vetro a parete singola. Il design tubolare facilita la presa mentre lo stelo cavo consente bolle più lisce e un'emanazione più uniforme degli aromi. Grazie al design originale, saranno perfetti per le tue occasioni speciali. Capacità: 150ml.

**EN Set of 2 double wall flutes in borosilicate glass.** The double wall keeps your champagne cool for longer than single wall glass. The tubular design makes it easier to hold while the hollow stem allows for smoother bubbles and a more uniform emanation of aromatic compounds. Thanks to the original design, they will be perfect for your special occasions. Capacity: 150ml.

**FR Ensemble de 2 flûtes à double paroi en verre borosilicate.** La double paroi permet de conserver la fraîcheur de votre champagne plus longtemps que les verres à simple paroi. La forme tubulaire facilite la prise en main, tandis que la tige creuse permet des bulles plus douces et une libération plus uniforme des arômes. Grâce à leur design original, ils seront parfaits pour vos occasions spéciales. Contenance: 150ml.



Ø 5 cm

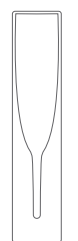

23 cm



Sì lavastoviglie  
Dishwasher safe  
Lave-vaisselle possible



Sì microonde  
Microwave safe  
Micro-ondes possible



8 053300 572779





### WD318

**IT** Set 6 ciotole in vetro borosilicato doppia parete 170ml.

**EN** Set of 6 bowls in borosilicate glass, double wall 170ml.

**FR** Set de 6 bols en verre borosilicate à double paroi de 170ml.

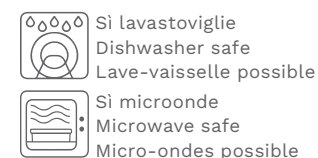
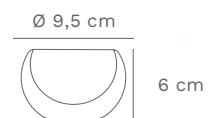

### WD174

**IT** Set 6 bicchierini, doppia parete 80ml

**EN** Set of 6 small glasses, double wall 80ml.

**FR** Set de 6 petits verres à double paroi de 80ml.



### WD319

**IT** Set 6 bicchierini liquore in vetro borosilicato doppia parete 100ml.

**EN** Set of 6 glasses in borosilicate glass, double wall 100ml.

**FR** Set de 6 verres à liqueur en verre borosilicate à double paroi de 100ml.

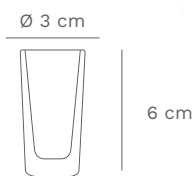

### WD173

**IT** Brocca doppia parete 800ml.

**EN** Double glass Pitcher 800ml.

**FR** Carafe à double paroi de 800ml.

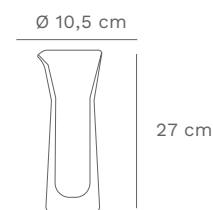

**WD615**

**IT** Set 6 bicchieri in vetro borosilicato con scritta decorativa e fondo colorato. Capacità: 250ml.

**EN** Set composed by 6 glasses in borosilicate glass with decorating quote and colored bottom. Capacity: 250ml.

**WDF615** *Sans inscription*

**FR** Ensemble de 6 verres en verre borosilicate et fond coloré. Contenance: 250ml.

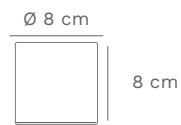

No lavastoviglie  
No dishwasher  
Pas de lave-vaisselle

Si microonde  
Microwave safe  
Micro-ondes possible



**WD606**

**IT** Caraffa in vetro borosilicato con manico blu e scritta decorativa. Capacità: 1,3L.

**EN** Borosilicate glass jug with blue handle and decorating quote. Capacity: 1,3L.

**WDF606** *Sans inscription*

**FR** Pichet en verre borosilicate avec poignée teintée en bleue dans la masse du verre. Contenance: 1,3L.

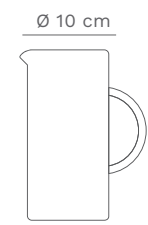

Si lavastoviglie  
Dishwasher safe  
Lave-vaisselle possible

Si microonde  
Microwave safe  
Micro-ondes possible



### WD605



**IT Brocca decanter in vetro borosilicato** con manico marrone e scritta decorativa. La sua forma moderna rende questo decanter unico e originale. Capacità: 1,6L.

**EN Borosilicate glass pitcher decanter** with brown handle and decorating quote. Its modern shape gives this decanter an original and unique look. Capacity: 1,6L.

### WDF605 *Sans inscription*

**FR Carafe en verre borosilicate** avec poignée colorée. Sa forme moderne rend cette carafe unique et originale. Capacité: 1,6L.



-  Si lavastoviglie  
Dishwasher safe  
Lave-vaisselle possible
-  Si microonde  
Microwave safe  
Micro-ondes possible



### WD603

**IT Oliera in vetro borosilicato** con manico giallo e scritta decorativa. La sua forma moderna rende questa oliera unica e originale. Capacità: 500ml.

**EN Borosilicate glass oil bottle** with yellow handle and decorating quote. The modern shape gives this oil bottle an original and unique look. Capacity: 500ml.

### WDF603 *Sans inscription*

**FR Pichet à huile en verre borosilicate** avec poignée jaune. Sa forme moderne rend ce pichet à huile unique et original. Contenance: 500ml.



-  Si lavastoviglie  
Dishwasher safe  
Lave-vaisselle possible
-  Si microonde  
Microwave safe  
Micro-ondes possible



### WD604

**IT Oliera in vetro borosilicato** con manico marrone e scritta decorativa. La sua forma moderna rende questa oliera unica e originale. Capacità: 500ml.



**EN Borosilicate glass oil bottle** with brown handle and decorating quote. The modern shape gives this oil bottle an original and unique look. Capacity: 500ml.

### WDF604 *Sans inscription*

**FR Pichet à huile en verre borosilicate** avec poignée marron. Sa forme moderne rend ce pichet à huile unique et original. Contenance: 500ml.



18 cm

-  Si lavastoviglie  
Dishwasher safe  
Lave-vaisselle possible
-  Si microonde  
Microwave safe  
Micro-ondes possible



### WD598

**IT Set 6 tazzine da caffè in vetro borosilicato** con manico colorato e scritta decorativa. La forma moderna di queste tazzine le rende uniche e originali. Capacità: 100ml.

**EN Set composed by 6 coffee cups in borosilicate glass** with colored handle and decorating quote. The modern shape of these coffee cups make them unique and original. Capacity: 100ml.

### WDF598 *Sans inscription*



**FR Set de 6 tasses à café en verre borosilicate** avec poignée colorée. La forme moderne de ces tasses les rend uniques et originales. Contenance: 100ml.

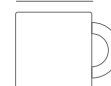

Ø 5,5 cm



5,5 cm

-  Si lavastoviglie  
Dishwasher safe  
Lave-vaisselle possible
-  Si microonde  
Microwave safe  
Micro-ondes possible



### WD597

**IT Set 4 tazze da tè in vetro borosilicato** con manico colorato e scritta decorativa. La forma moderna di queste tazze le rende uniche e originali. Capacità: 250ml.

**EN Set composed by 4 tea cups in borosilicate glass** with colored handle and decorating quote. The modern shape of these tea cups make them unique and original. Capacity: 250ml.

### WDF597 *Sans inscription*

**FR Set de 4 mugs en borsilicate** avec poignée colorée. La forme moderne de ces tasses les rend uniques et originales. Contenance: 250ml.



Ø 7,5 cm

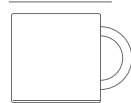

7,5 cm



Si lavastoviglie  
Dishwasher safe  
Lave-vaisselle possible



Si microonde  
Microwave safe  
Micro-ondes possible

WD597



8°053300°571482°

### WD596

**IT Teiera in vetro borosilicato** con manico colorato e scritta decorativa. La sua forma moderna e il filtro sul beccuccio rendono questa teiera unica e originale. Capacità: 900ml.

**EN Borosilicate glass teapot** with colored handle and decorating quote. Its modern shape and the filter on the spout give this teapot an original and unique look. Capacity: 900ml.

### WDF596 *Sans inscription*

**FR Théière en verre borosilicate** avec filtre ressort sur le bec verseur. Elle est équipée d'un filtre ressort. Les poignées en verre teinté dans la masse sont proposées en deux couleurs: verte et banche. Contenance: 900ml.



WD596B



8°053300°571468°

WD596V



8°053300°571475°

Ø 13 cm



16,5 cm

TEIERA | TEAPOT | THÉIÈRE



Si lavastoviglie  
Dishwasher safe  
Lave-vaisselle possible



Si microonde  
Microwave safe  
Micro-ondes possible

FILTRO | FILTER | FILTRE



No microonde  
No microwave  
Pas de micro-ondes



### WD599

**IT Tisaniera in vetro borosilicato** con manico colorato, filtro in acciaio inossidabile con tappo in vetro e scritta decorativa. La forma moderna di questa tisaniera la rende unica e originale. Capacità: 420ml.

**EN Mug in borosilicate glass** with colored handle, stainless steel filter with glass lid and decorative quote. The modern shape of this mug makes it unique and original. Capacity: 420ml.

### WDF599 *Sans inscription*

**FR Tisanière en verre borosilicate** avec une poignée colorée, filtre en acier inoxydable avec un couvercle en verre. La forme moderne de cette théière la rend unique et originale. Contenance : 420 ml.

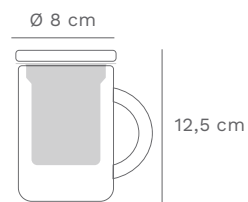

TISANIERA | MUG | TISANIÈRE  
 Si lavastoviglie  
 Dishwasher safe  
 Lave-vaisselle possible  
 Si microonde  
 Microwave safe  
 Micro-ondes possible

FILTRO | FILTER | FILTRE  
 No microonde  
 No microwave  
 Pas de micro-ondes

### WD600, WD601B, WD602

**IT Barattoli in vetro borosilicato** con tappo ermetico, manico colorato e scritta decorativa.

**EN Jars in borosilicate glass** with airtight lid, colored handle and decorating quote.

### *Sans inscription*

**FR Bocaux en verre borosilicate** avec couvercle hermétique et poignée colorée dans la masse.



Si lavastoviglie  
 Dishwasher safe  
 Lave-vaisselle possible  
 Si microonde  
 Microwave safe  
 Micro-ondes possible

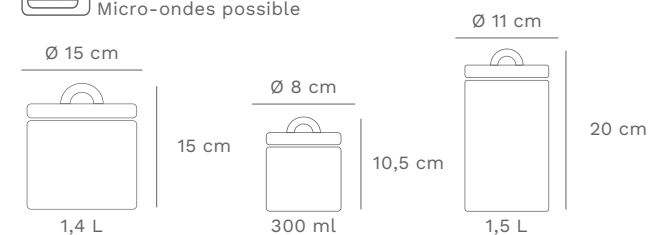

# OLIMPIA LINE

## WD752, WD753, WD754

**IT Vaso in vetro colorato.** Porta fiori ed essenze a forma sferica con base cilindrica. Dona eleganza e originalità alla tua casa. Sticks neri inclusi.

**EN Colored borosilicate glass vase.** Spherical flower and essence holder with cylindrical base. Give elegance and originality to your home. Black sticks included.

**FR Vase en verre coloré.** Vase pour fleurs et diffuseur d'essences en forme sphérique avec base cylindrique. Parfait également comme vase de décoration. Bâtonnets noirs inclus.



WD752G



8 053300 577583



WD753V



8 053300 577590



WD754AM



8 053300 577606

 Lavare con un panno umido  
Wash with a damp cloth  
Laver avec un chiffon humide

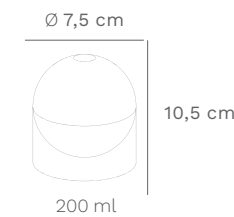
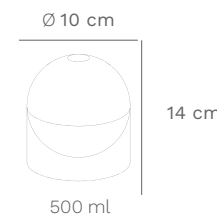
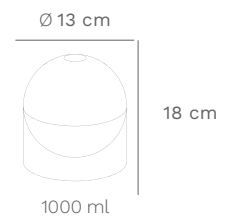

### WD649

**IT** Teiera in vetro borosilicato con manico colorato ad anello con filtro in acciaio inossidabile. Il design moderno rende i tuoi momenti di relax unici ed originali. Capacità 800ml.

**EN** Teapot made of borosilicate glass with colored ring handle with stainless steel filter. This modern design makes your moments of relaxation unique and original. Capacity 800ml.

**FR** Théière en verre borosilicate avec poignée à anneau colorée avec filtre en acier inoxydable. Ce design moderne rend vos moments de détente uniques et originaux. Contenance 800ml.



WD649AR  
8 053300 578283



WD649AZ  
8 053300 578290



WD649G  
8 053300 573462



WD649PE  
8 053300 573455

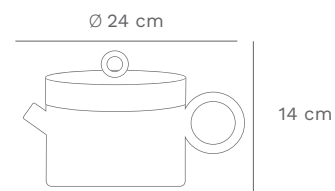

No lavastoviglie  
No dishwasher  
Pas de lave-vaisselle  
No microonde  
No microwave  
Pas de micro-ondes

Capacità 800 ml.  
Capacity 800 ml.  
Contenance 800 ml.

### WD766

**IT** Teiera in vetro borosilicato con manico colorato ad anello con filtro in acciaio inossidabile. Il design moderno rende i tuoi momenti di relax unici ed originali. Capacità 1,2 L.

**EN** Teapot made of borosilicate glass with colored ring handle with stainless steel filter. This modern design makes your moments of relaxation unique and original. Capacity 1,2 L.

**FR** Théière en verre borosilicate avec poignée à anneau colorée avec filtre en acier inoxydable. Ce design moderne rend vos moments de détente uniques et originaux. Contenance 1,2 L.



WD766BL  
8 053300 578122



WD766RO  
8 053300 578115

Capacità 1,2 L.  
Capacity 1,2 L.  
Contenance 1,2 L.

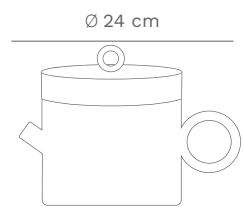

No lavastoviglie  
No dishwasher  
Pas de lave-vaisselle  
No microonde  
No microwave  
Pas de micro-ondes



### WD646, WD647, WD648

**IT** Barattolo in vetro borosilicato con manico colorato ad anello. Un articolo originale che dona colore e allegria alla tua cucina.

**EN** Jar made of borosilicate glass with a colored ring handle. An original item that brings color and joy to your kitchen.

**FR** Pot en verre borosilicate avec poignée colorée à anneau. Un article original qui donne de la couleur et de la gaieté à votre cuisine.

No lavastoviglie  
No dishwasher  
Pas de lave-vaisselle  
No microonde  
No microwave  
Pas de micro-ondes



WD646RO  
8 053300 573424

WD647AZ  
8 053300 573431

WD648AR  
8 053300 573448

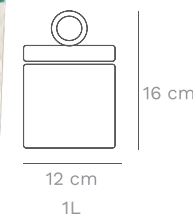
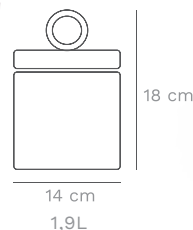

### WD650

**IT** Caraffa in vetro borosilicato con manico colorato ad anello. Perfetta per gustare le tue bevande preferite in qualsiasi momento. Capacità 1,2L.

**EN** Pitcher made of borosilicate glass with colored ring handle. Perfect for enjoying your favorite beverages at any time. Capacity 1,2L.

**FR** Carafe en verre borosilicate avec poignée à anneau colorée. Parfait pour déguster vos boissons préférées à chaque occasion. Contenance 1,2L.



Capacità 1,2 L.  
Capacity 1,2 L.  
Contenance 1,2 L.

WD650V  
8 053300 573479

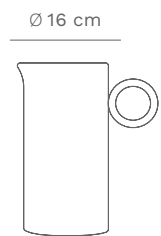

Si lavastoviglie  
Dishwasher safe  
Lave-vaisselle possible  
Si microonde  
Microwave safe  
Micro-ondes possible



## WD651

**IT Set 6 tazze da caffè in vetro borosilicato con manico colorato ad anello.** Un assortimento adatto ad ogni occasione che donerà colore ed unicità alla tua tavola. Capacità 100ml.

**EN Set of 6 borosilicate glass coffee mugs with colored ring handle.** This range is suitable for any occasion and it will bring color and uniqueness to your table 100ml. capacity.

**FR Set de 6 tasses à café en verre borosilicate avec poignée annulaire colorée.** Un assortiment adapté à chaque occasion qui apportera couleur et originalité à votre table. Contenance 100ml.



Capacità 100 ml.  
Capacity 100 ml.  
Contenance 100 ml.

Ø 5,5 cm

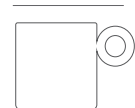

5,2 cm



Si lavastoviglie  
Dishwasher safe  
Lave-vaisselle possible



Si microonde  
Microwave safe  
Micro-ondes possible



## WD652

**IT Set 4 tazze in vetro borosilicato con supporto in vetro borosilicato.** La forma moderna di queste tazze con manico ad anello le rende uniche ed originali, perfette per una pausa all'insegna del gusto e dello stile. Capacità 100ml.

**EN Set of 4 borosilicate glass mugs with borosilicate glass holder.** The modern shape of these mugs with a ring handle makes them unique and original, perfect for a tasteful and stylish break 100ml. capacity.

**FR Set de 4 tasses en verre borosilicate avec porte-verre en verre borosilicate.** La forme moderne de ces tasses avec une poignée en anneau les rend uniques et originales, parfaites pour une pause de bon goût et élégante.

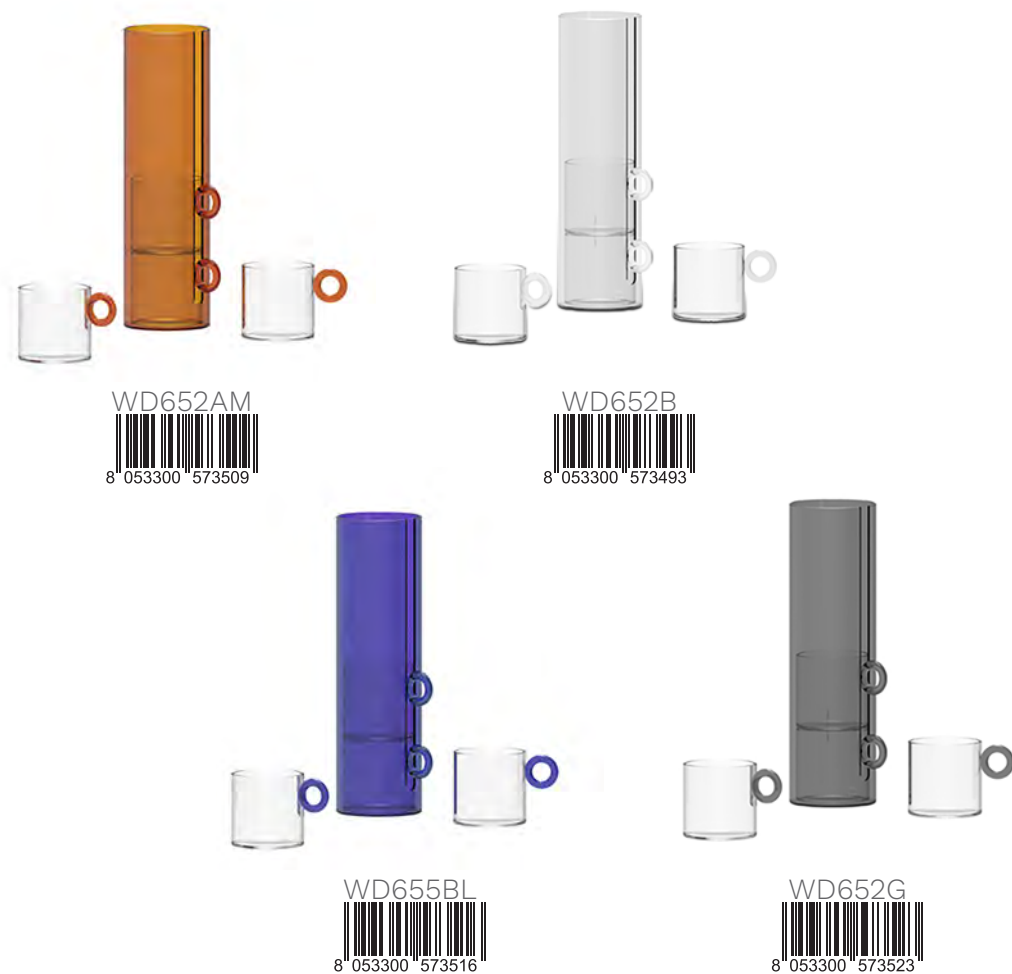

Capacità 100ml.  
Capacity 100ml.  
Contenance 100ml.



Ø 6,5 cm

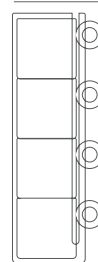

22,5 cm



Si lavastoviglie  
Dishwasher safe  
Lave-vaisselle possible



Si microonde  
Microwave safe  
Micro-ondes possible

## WD653

**IT Set 4 tazze da tè in vetro borosilicato con manico colorato ad anello.** Perfette per godersi un momento di relax all'insegna del gusto e dello stile. Capacità 300ml.

**EN Set of 4 borosilicate glass teacups with colored ring handle.** Perfect for enjoying a relaxing moment of taste and style 300ml. capacity.

**FR Set de 4 tasses à thé en verre borosilicate avec poignée annulaire colorée.** Parfait pour profiter d'un moment de détente avec goût et style. Contenance 300ml.



WD653  
8° 053300° 573530°

Capacità 300ml.  
Capacity 300ml.  
Contenance 300ml.



Ø 7,8 cm

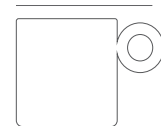

7 cm



Si lavastoviglie  
Dishwasher safe  
Lave-vaisselle possible



Si microonde  
Microwave safe  
Micro-ondes possible

## WD654

**IT Set 6 bicchieri in vetro borosilicato.** Il particolare decoro ad anello renderà la tua tavola unica ed originale. Capacità 350ml.

**EN Set of 6 borosilicate glass tumblers.** The special ring decoration will make your table unique and original. Capacity 350ml.

**FR Set de 6 verres en verre borosilicate.** La décoration spéciale des anneaux rendra votre table unique et originale. Contenance 350ml.



WD654  
8 053300 573547

Capacità 350ml.  
Capacity 350ml.  
Contenance 350ml.



Ø 8,3 cm



7,3 cm



Si lavastoviglie  
Dishwasher safe  
Lave-vaisselle possible



Si microonde  
Microwave safe  
Micro-ondes possible

## WD655

**IT Tisaniera con manico ad anello, filtro e tappo in vetro borosilicato.** Perfetta per la preparazione di tisane ed infusi, rendendo unico ed originale ogni tuo momento di relax. Capacità 450ml.

**EN Herbal tea pot with ring handle, filter and cap made of borosilicate glass.** Perfect for preparing herbal teas and infusions, making every relaxing moment unique and original. 450ml. capacity.

**FR Tisanière avec poignée annulaire, filtre et bouchon en verre borosilicate.** Parfait pour préparer des tisanes et des infusions, rendant chaque moment de détente unique et original. Contenance 450ml.



WD655AM  
8 053300 573561



WD655BL  
8 053300 573554



WD655GI  
8 053300 573578

Capacità 450ml.  
Capacity 450ml.  
Contenance 450ml.



Ø 8 cm

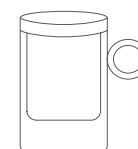

12 cm



Si lavastoviglie  
Dishwasher safe  
Lave-vaisselle possible



Si microonde  
Microwave safe  
Micro-ondes possible

# ACAPULCO LINE



## WD635

**IT** Brocca in vetro borosilicato con simpatica scritta in vetro colorato realizzata a mano. Capacità 1,2L.

**EN** Pitcher in borosilicate glass with with lettering in colored glass made by hand. Capacity 1,2L.

**FR** Pichet en verre borosilicate avec une inscription en verre coloré faite à la main. Capacité de 1,2L.



Handmade



Ø 10 cm

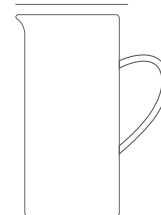

20 cm



Si lavastoviglie  
Dishwasher safe  
Lave-vaisselle possible



Si microonde  
Microwave safe  
Micro-ondes possible

WD635HAP



8° 053300° 572960

### WD634

**IT** Bicchiere da cocktail in vetro borosilicato con scritta decorativa in vetro colorato realizzata a mano. Capacità 450ml.

**EN** Cocktail glass in borosilicate glass with decorative lettering in colored glass made by hand. Capacity 450ml.

**FR** Verre à cocktail en verre borosilicaté avec inscription en verre teinté fabriqué à la main. Capacité 450ml.



WD634BEE



8 053300 572908



WD634GIN



8 053300 572953



WD634MAR



8 053300 572946



WD634MOJ



8 053300 572915



WD634SAN



8 053300 572939





WD634SPR



8 053300 572922



-  Si lavastoviglie  
Dishwasher safe  
Lave-vaisselle possible
-  Si microonde  
Microwave safe  
Micro-ondes possible



Handmade

### WD680

**IT** Set 6 cannucce riutilizzabili colorate in vetro borosilicato con scovolino per la pulizia. Nel pieno rispetto dell'ambiente donano un tocco di colore ed allegria alle tue bevande, perfette per differenziare il proprio drink da quello degli altri. Colori rosa, verde, arancione, grigio, blu, giallo.

**EN** Set of 6 reusable colored borosilicate glass straws with cleaning brush. In full respect of the environment, they give a touch of color and joy to your drinks, differentiating them from others.

**FR** Set de 6 pailles colorées réutilisables en verre borosilicate avec brosette de nettoyage. En respectant pleinement l'environnement, elles donnent une touche de couleur et de joie à vos boissons, en différenciant votre boisson de celle des autres.



WD680





8 053300 574667

Ø 0,8 cm



20 cm

-  Si lavastoviglie  
Dishwasher safe  
Lave-vaisselle possible
-  Si microonde  
Microwave safe  
Micro-ondes possible



# BALAT LINE

## WD736, WD737, WD738

**IT** Alzata in vetro colorata. Caratterizzata da forme irregolari e colori brillanti, dona colore ed unicità alla tua tavola.

**EN** Elevated colored glass cakestand. Characterized by irregular shapes and bright colors, it adds color and uniqueness to your table.

**FR** Plateau surélevé en verre coloré. Caractérisé par des formes irrégulières et des couleurs vives, il ajoute de la couleur et de l'unicité à votre table.



WD736AR



WD737BO



WD738LI



-  No lavastoviglie  
No dishwasher  
Pas de lave-vaisselle
-  No microonde  
No microwave  
Pas de micro-ondes

## WD739

**IT Insalatiera in vetro colorata.** Servi e gusta le tue insalate in maniera accattivante grazie alla particolarità delle sue forme e dei suoi colori.

**EN Colored glass salad bowl.** Serve and enjoy your salads in an eye-catching way thanks to the particularity of its shapes and colors.

**FR Saladier en verre coloré.** Servez et dégustez vos salades de manière attrayante grâce à la particularité de ses formes et de ses couleurs.



WD739AR



8 053300 576517



WD739BO



8 053300 577965



WD739LI



8 053300 577958



Ø 25 cm

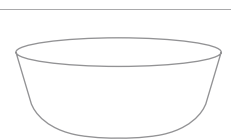

8 cm



No lavastoviglie  
No dishwasher  
Pas de lave-vaisselle



No microonde  
No microwave  
Pas de micro-ondes



### WD740

**IT Set 2 coppette in vetro colorate.** Servi le tue preparazioni dolci e salate con colore e stile, rendendo la tua tavola colorata ed originale. Capacità 300 ml.

**EN Set of 2 colored glass bowls.** Serve your sweet and savory preparations with color and style, making your table colorful and original. 300 ml capacity.

**FR Set de 2 bols en verre coloré.** Servez vos préparations sucrées et salées avec couleur et style, rendant votre table colorée et originale. Contenance de 300 ml.



WD740T



WD740BO



WD740V



### WD741

**IT Set 2 ciotole in vetro colorate.** Adatti per servire le tue preparazioni calde o fredde, dolci o salate con colore e stile, rendendo la tua tavola colorata ed originale. Capacità 500 ml.

**EN Set of 2 colored glass bowls.** Suitable for serving your hot or cold, sweet or savory preparations with color and style, making your table colorful and original. 500 ml capacity.

**FR Set de 2 bols en verre coloré.** Idéaux pour servir vos préparations chaudes ou froides, sucrées ou salées avec couleur et style, rendant votre table colorée et originale. Capacité de 500 ml.



WD741AR



WD741BO



WD741LI



### WD742

**IT Set 2 piattini in vetro colorati.** Adatti per servire le tue preparazioni in maniera originale, donando colore e unicità alla tua tavola.

**EN Set of 2 colored glass plates.** Suitable for serving your creations in an original way, adding color and uniqueness to your table.

**FR Set de 2 assiettes en verre coloré.** Idéal pour servir vos créations de manière originale, ajoutant de la couleur et de l'unicité à votre table.



WD742AR



8 053300 576753

WD742BO



8 053300 576685

WD742LI



8 053300 576678



18 cm



No lavastoviglie  
No dishwasher  
Pas de lave-vaisselle



No microonde  
No microwave  
Pas de micro-ondes

### WD743

**IT Set 2 piatti in vetro colorati.** Adatti per servire le tue preparazioni in maniera originale, donando colore e unicità alla tua tavola.

**EN Set of 2 colored glass plates.** Suitable for serving your creations in an original way, adding color and uniqueness to your table.

**FR Set de 2 assiettes en verre coloré.** Idéal pour servir vos créations de manière originale, ajoutant de la couleur et de l'unicité à votre table.

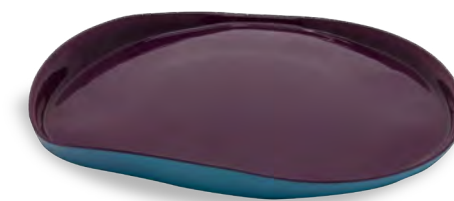
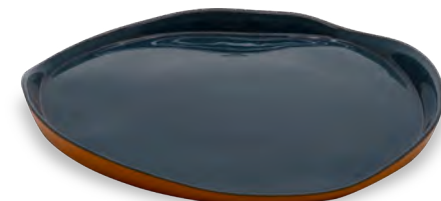

WD743AR



8 053300 576708

WD743LI



8 053300 576715

WD743T



8 053300 576692



21 cm



No lavastoviglie  
No dishwasher  
Pas de lave-vaisselle



No microonde  
No microwave  
Pas de micro-ondes



**WD744**

**IT Piatto piano in vetro colorato.** Dona colore ed eleganza alla tua tavola, rendendola unica ed originale grazie alle forme irregolari che lo caratterizzano. Perfetto anche come piatto a servire o centrotavola.

**EN Flat plate in colored glass.** Adds color and elegance to your table, making it unique and original thanks to its irregular shapes. Perfect also as a serving plate or centerpiece.

**FR Assiette plate en verre coloré.** Ajoutez de la couleur et de l'élégance à votre table, la rendant unique et originale grâce à ses formes irrégulières. Parfait également en tant qu'assiette de service ou centre de table.



WD744AR  
8 053300 576739





WD744LI  
8 053300 576746



WD744BO  
8 053300 576722



28 cm

 No lavastoviglie  
 No dishwasher  
 Pas de lave-vaisselle  
 No microonde  
 No microwave  
 Pas de micro-ondes

**WD737**

**IT Alzata in vetro colorata.** Grazie alle sue forme irregolari e ai suoi colori brillanti ti permette di servire dessert ed aperitivi in modo accattivante, rendendo la tua tavola elegante ed originale durante le feste.

**EN Colored glass cakestand.** Thanks to its irregular shapes and bright colors, it allows you to serve desserts and appetizers in an attractive way, making your table elegant and original during the holidays.

**FR Plateau surélevé en verre.** Grâce à ses formes irrégulières et ses couleurs vives, il vous permet de servir des desserts et des apéritifs de manière attrayante, rendant votre table élégante et originale pendant les fêtes.



WD737PER



8 053300 577910



Ø 21 cm

9,5 cm



No lavastoviglie  
No dishwasher  
Pas de lave-vaisselle



No microonde  
No microwave  
Pas de micro-ondes



## WD738

**IT Alzata in vetro colorata.** Grazie alle sue forme irregolari e ai suoi colori brillanti ti permette di servire dessert ed aperitivi in modo accattivante, rendendo la tua tavola elegante ed originale durante le feste.

**EN Colored glass cakestand.** Thanks to its irregular shapes and bright colors, it allows you to serve desserts and appetizers in an attractive way, making your table elegant and original during the holidays.

**FR Plateau surélevé en verre.** Grâce à ses formes irrégulières et ses couleurs vives, il vous permet de servir des desserts et des apéritifs de manière attrayante, rendant votre table élégante et originale pendant les fêtes.



WD738ORO

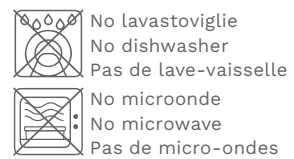

### WD742

**IT Set 2 piatti in vetro colorati.** Grazie alle forme irregolari e ai colori brillanti potrai servire le tue preparazioni in modo accattivante ed originale, rendendo la tua tavola elegante ed originale durante le feste.

**EN Set of 2 colored glass plates.** Thanks to their irregular shapes and bright colors, you can serve your dishes in an attractive and original way, making your table elegant and unique during the holidays.

**FR Ensemble de 2 assiettes en verre coloré.** Grâce à leurs formes irrégulières et leurs couleurs vives, vous pouvez servir vos plats de manière attrayante et originale, rendant votre table élégante et unique pendant les fêtes.



WD742ORO



8 053300 577934



Ø 18 cm



No lavastoviglie  
No dishwasher  
Pas de lave-vaisselle  
No microonde  
No microwave  
Pas de micro-ondes

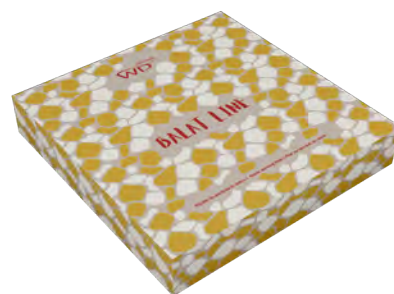

### WD749

**IT Piatto panettone in vetro colorato.** Grazie alle forme irregolari e ai colori brillanti potrai servire le tue preparazioni in modo accattivante ed originale, rendendo la tua tavola brillante ed elegante durante le feste.

**EN Colored glass panettone plate.** Thanks to their irregular shapes and bright colors, you can serve your dishes in an attractive and original way, making your table elegant and unique during the holidays.

**FR Assiette à panettone en verre coloré.** Grâce à leurs formes irrégulières et leurs couleurs vives, vous pouvez servir vos plats de manière attrayante et originale, rendant votre table élégante et unique pendant les fêtes.



WD749ORO



8 053300 577897

WD749PER



8 053300 577903



Ø 32 cm



No lavastoviglie  
No dishwasher  
Pas de lave-vaisselle  
No microonde  
No microwave  
Pas de micro-ondes

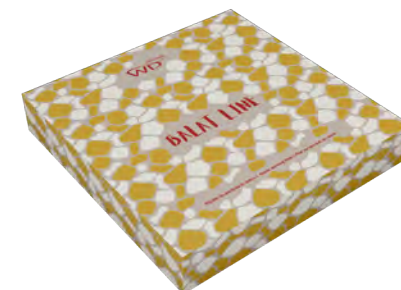

# NEW YORK LINE



## WD405

**IT** Bottiglia colorata in acrilico 1L. Decorazione verticale a rilievo effetto vetro.

**EN** Colored acrylic bottle 1L. Embossed vertical decoration with glass effect.

**FR** Bouteille colorée avec stris en acrylique 1L. Décoration verticale en relief effet verre.



WD405AM  
8 033040 744940



WD405AVI  
8 053300 574384



WD405BL  
8 053300 574377



WD405M  
8 053300 574360



WD405R  
8 033040 745909



WD405T  
8 033040 744957



WD405TR  
8 033040 745916



WD405V  
8 033040 744964



No microonde  
No microwave  
Pas de micro-ondes

No lavastoviglie  
No dishwasher  
Pas de lave-vaisselle



### WD406

**IT** Set 2 bicchieri colorati in acrilico 370ml. Decorazione verticale a rilievo effetto vetro.

**EN** Set of 2 colored acrylic glasses 370ml. Embossed vertical decoration with glass effect.

**FR** Set 2 gobelets colorés et striés en acrylique. Contenance: 370ml. Décoration verticale en relief effet de verre.

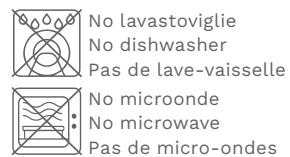
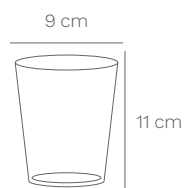

### WD407

**IT** Brocca colorata in acrilico 2,3L. Decorazione verticale a rilievo effetto vetro.

**EN** Colored acrylic pitcher 2,3L. Embossed vertical decoration with glass effect.

**FR** Pichet coloré et strié en acrylique. Contenance: 2,3L. Décoration en relief vertical effet verre.

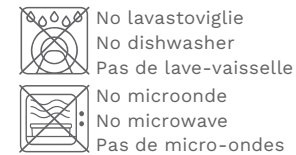

### WD408

**IT** Set 2 calici colorati in acrilico 460ml. Decorazione verticale a rilievo effetto vetro.

**EN** Set of 2 colored acrylic goblets 460ml. Embossed vertical decoration with glass effect.

**FR** Set de 2 verres à pied striés et colorés en acrylique. Contenance 460ml. Décoration verticale en relief effet verre.



### WD674

**IT** Set 6 bicchieri colorati in acrilico 370 ml. Colori: ambra, verde, turchese, marrone, rosso e blu. Decorazione verticale a rilievo effetto vetro.

**EN** Set of 6 colored acrylic glasses 370 ml. Colors: amber, green, turquoise, brown, red and blue. Embossed vertical decoration with glass effect.

**FR** Set 6 gobelets colorés et striés en acrylique. Contenance: 370 ml. Couleurs: ambre, vert, turquoise, marron, rouge et bleu. Décoration verticale en relief effet de verre.





## NEW YORK GOLD



WD405GOLD



8 033040 747699



WD406GOLD



8 033040 747705



WD407GOLD



8 033040 747712



WD408GOLD



8 033040 747729

### WD405GOLD

**IT** Bottiglia in acrilico 1L. Decorazione verticale a rilievo effetto vetro con aggiunta finitura oro.

**EN** Acrylic bottle 1L. Embossed vertical decoration with glass effect and gold finishing.

**FR** Bouteille en acrylique de 1L. Décor vertical en relief, effet verre, avec finition dorée.



No lavastoviglie  
No dishwasher  
Pas de lave-vaisselle



No microonde  
No microwave  
Pas de micro-ondes

### WD406GOLD

**IT** Set 2 bicchieri in acrilico con finitura bordo oro 370ml. Decorazione verticale a rilievo effetto vetro.

**EN** Set of 2 acrylic glasses with gold finishing 370ml. Embossed vertical decoration with glass effect.

**FR** Set de 2 verres en acrylique avec finition en bordure dorée 370ml. Décoration verticale en relief avec effet verre.

### WD407GOLD

**IT** Brocca in acrilico 2,3L. Decorazione verticale a rilievo effetto vetro con aggiunta finitura oro.

**EN** Acrylic Pitcher with glass effect and gold finishing 2,3L. Embossed vertical decoration with glass effect.

**FR** Carafe en acrylique de 2,3L. Décor vertical en relief effet verre avec finition dorée ajoutée.

### WD408GOLD

**IT** Set 2 calici con bordo oro in acrilico con aggiunta finitura oro 460ml. Decorazione verticale a rilievo effetto vetro.

**EN** Set of 2 transparent goblets with glass effect and gold finishing 460ml. Embossed vertical decoration with glass effect.

**FR** Set de 2 verres à pied en acrylique bordés d'or 460 ml. Décoration verticale en relief effet verre.

# NAPA LINE



## WD768

**IT Glacette morbida** raffredda bottiglie con eco pelliccia decorativa. Originale ed elegante, perfetta per rendere unica la tua tavola in ogni occasione. Per un corretto utilizzo riporre in freezer per alcune ore, una volta tolta, infilare la bottiglia al suo interno per avere un vino sempre fresco durante il pasto.

**EN Soft glacette** bottle cooler with decorative faux fur. Original and elegant, perfect for making your table unique on any occasion. For proper use, store in the freezer for a few hours. Once removed, insert the bottle inside to keep wine cool during the meal.

**FR Rafraîchisseur de bouteille souple** pour refroidir les bouteilles avec une fausse fourrure décorative. Original et élégant, parfait pour rendre votre table unique en toute occasion. Pour une utilisation correcte, ranger au congélateur pendant quelques heures. Une fois retiré, insérez la bouteille à l'intérieur pour garder le vin frais pendant le repas.



WD768B



8 053300 578306



WD768BE



8 053300 578313



15,5 cm

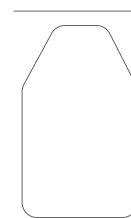

22,5 cm



WD768N



8 053300 578320



WD768R



8 053300 578337





### WD018

**IT Glacette morbida raffreddabottiglie decorata.** Per un corretto utilizzo riporre in freezer per alcune ore, una volta tolta infila la bottiglia al suo interno per avere un vino sempre fresco durante il pasto.

**EN Soft decored glacette bottle cooler.** For a correct use, place in the freezer for a few hours, once removed put the bottle inside to keep your wine cool during the meal.

**FR Rafrâchisseur de bouteille décoré pour refroidir les bouteilles.** Pour une bonne utilisation, mettre au congélateur pendant quelques heures, une fois retiré, glisse la bouteille à l'intérieur pour avoir un vin toujours frais pendant le repas.



WD018DAB  
8 053300 573226



WD018DAG  
8 053300 573233



WD018DAM  
8 053300 570263



WD018FOG  
8 053300 573257



15,5 cm

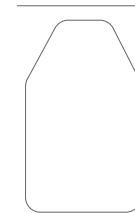

22,5 cm



WD018KAS  
8 053300 573219



WD018MAIO  
8 053300 570232



WD018PET  
8 053300 573240



WD018VIN  
8 053300 573264



## WD018

**IT Glacette morbida raffreddabottiglie monocolore.** Per un corretto utilizzo riporre in freezer per alcune ore, una volta tolta infila la bottiglia al suo interno per avere un vino sempre fresco durante il pasto.

**EN Soft monochrome glacette bottle cooler.** For a correct use, place in the freezer for a few hours, once removed put the bottle inside to keep your winecool during the meal.

**FR Rafrâchisseur de bouteille unicolore.** Pour une utilisation correcte, placez la bouteille dans le congélateur pendant quelques heures, une fois retirée, placez la bouteille à l'intérieur pour avoir un vin toujours frais pendant le repas.



WD018B



8 033040 744261



WD018BEI



8 053300 573196



WD018BLACK



8 032646 260519



WD018BLU



8 053300 573202



15,5 cm

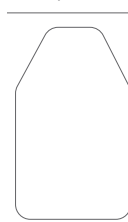

22,5 cm



WD018BOR



8 053300 573189



WD018GOLD



8 033040 743240



WD018RED



8 033040 743233



WD018SILVER



8 033040 743226



## WD440T

**IT Glacette a doppia parete (interno acciaio ed esterno plastica) per bottiglie 0,75L. e spumanti.** Ideale per mantenere in temperatura di degustazione i tuoi vini, spumanti e altre bevande.

**EN Double wall ice bucket (stainless steel and plastic) for bottles of 0,75L. and champagne.** Keeps your wine and drinks at correct serving temperature.

**FR Rafrâchisseur de bouteille à double paroi (intérieur acier et extérieur plastique) pour bouteilles de 750ml et vins mousseux.** Idéal pour conserver vos vins, vins mousseux et autres boissons à la température de dégustation.



WD440T



8 033040 745534

Ø 11,5 cm

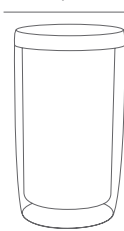

20 cm



Si lavastoviglie  
Dishwasher safe  
Lave-vaisselle possible



No microonde  
No microwave  
Pas de micro-ondes



# ROMA LINE

## WD637

**IT Cavatappi elettrico in finitura nero opaco.** Rimuove facilmente il tappo in pochi secondi ed è adatto alla maggior parte delle dimensioni standard di bottiglie. Tagliacapsule incluso nella confezione.

**EN Electric wine bottle opener in matt black finish.** It easily removes the cork in a few seconds and fits most standard wine bottle sizes. Foil cutter included in the package.

**FR Tire-bouchon électrique en finition noir mat.** Il extrait facilement le bouchon en quelques secondes et s'adapte à la plupart des tailles de bouteilles de vin standard. Coupe-capsules inclus dans l'emballage.

1



**IT** Ruota il taglia capsule attorno alla capsula per una o due volte per tagliare il sigillo.

**EN** Rotate the foil cutter around the foil seal for one to two circles to cut the foil seal.

**FR** Tournez-le coupe-capsules autour de la capsula pour un ou deux fois pour couper le joint.

2



**IT** Posiziona il cavatappi sopra la bottiglia e premi il pulsante inferiore affinché il tappo venga estratto.

**EN** Place the corkscrew over the bottle and press the lower button to make the cork pop out.

**FR** Placez le tire-bouchon sur la bouteille et appuyez sur le bouton inférieur pour faire extraire le bouchon deux fois pour couper le joint.

3



**IT** Premi il pulsante superiore per qualche secondo; il tappo uscirà automaticamente dal cavatappi.

**EN** Press the top button for a few seconds; the cork will automatically come out of the corkscrew.

**FR** Appuyez sur le bouton du haut pendant quelques secondes; le bouchon sortira automatiquement du tire-bouchon.



AA  
include  
integrated  
intégrée

Ø 5,5 cm

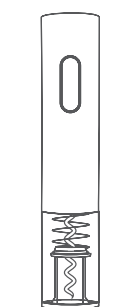

23,5 cm

WD637



8 053300 573004



### WD587

**IT Set di 4 sfere in acciaio inox riutilizzabili con pratico sacchetto in velluto nero.** Queste sfere manterranno il tuo cocktail sempre fresco e non annacquato. Per un corretto utilizzo riponi le sfere in freezer per min 2 ore, una volta raffreddate utilizzale nei tuoi cocktail.

**EN Set of 4 reusable stainless steel spheres with practical black velvet bag.** These spheres will keep your cocktail always cool and not watered down. For correct use, place the spheres in the freezer for at least 2 hours, once cooled use them in your cocktails.

**FR Set de 4 glaçons SPHERE en acier inoxydable avec pochette pratique en velours noir.** Ces sphères permettront à vos cocktails de rester toujours frais et non dilués. Pour une bonne utilisation, placez les boules au congélateur pendant au moins 2 heures. Une fois refroidies, utilisez-les dans vos cocktails.



*Non altera il sapore  
It does not alter the flavor  
Ne modifie pas le goût*

*Riutilizzabile  
Reusable  
Réutilisable*

WD587



8 053300 571338



Ø 4 cm



Si lavastoviglie  
Dishwasher safe  
Lave-vaisselle possible



No microonde  
No microwave  
Pas de micro-ondes



Non annacqua  
No watery drink  
Ne se dilue pas



Drink sempre freddo  
Always cool drink  
Boissons toujours froides

### WD588

**IT Set di 6 cubetti in acciaio inox riutilizzabili con pratico sacchetto in velluto nero.** Questi cubetti manterranno il tuo cocktail sempre fresco e non annacquato. Per un corretto utilizzo riponi i cubetti in freezer per min 2 ore, una volta raffreddati utilizzali nei tuoi cocktail.

**EN Set of 6 reusable stainless steel cubes with practical black velvet pouch.** These cubes will keep your cocktail always cool and not watered down. For a correct use, place the product in the freezer for at least 2 hours, once cooled use them in your cocktails.

**FR Set de 6 glaçons CUBE en acier inoxydable avec pochette pratique en velours noir.** Ces cubes permettront à votre cocktail d'être toujours frais et non dilué. Pour une bonne utilisation, placez les cubes au congélateur pendant au moins 2 heures. Une fois refroidis, utilisez-les dans vos cocktails.



*Non altera il sapore  
It does not alter the flavor  
Ne modifie pas le goût*

*Riutilizzabile  
Reusable  
Réutilisable*

WD588



8 053300 571345



2,7 cm

2,7 cm



Si lavastoviglie  
Dishwasher safe  
Lave-vaisselle possible



No microonde  
No microwave  
Pas de micro-ondes



Non annacqua  
No watery drink  
Ne se dilue pas



Drink sempre freddo  
Always cool drink  
Boissons toujours froides

## WD589

**IT Stick raffreddavino in acciaio inox con tappo ermetico.** Questo prodotto manterrà il tuo vino a temperatura per tutto il pasto. Per un corretto utilizzo riporre in freezer per circa 4 ore, inserire attraverso il collo della bottiglia.

**EN Stainless steel wine chiller stick with hermetic cap.** This product will keep your wine at temperature throughout the meal. For a correct use, place it in the freezer for about 4 hours, then insert it through the neck of the bottle. Dishwasher safe. After use, rinse it and dry it.

**FR Bâton rafraîchisseur de vin en acier inoxydable avec bouchon hermétique.** Ce produit maintiendra votre vin à température pendant tout le repas. Pour une utilisation correcte, placez-le au congélateur pendant environ 4 heures, puis insérez-le dans le goulot de la bouteille.



Ø 1,6 cm



32 cm

WD589



8 053300 571352



Si lavastoviglie  
Dishwasher safe  
Lave-vaisselle possible



No microonde  
No microwave  
Pas de micro-ondes



Non annacqua  
No watery drink  
Ne se dilue pas



Drink sempre freddo  
Always cool drink  
Boissons toujours froides

*Beccuccio antigoccia  
Anti drip spout  
Bec verseur anti-goutte*

*Non altera il sapore  
It does not alter the flavor  
Ne modifie pas le goût*

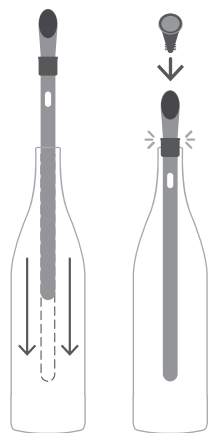

### WD607

**IT Set cocktail professionale in acciaio inox**, in astuccio tela con cinghia in ecopelle e maniglia per trasportarlo facilmente. Composto da 6 pezzi. Capacità Shaker: 700ml, Capacità Jigger: 35ml.

**EN Professional cocktail set in stainless steel**, in a canvas case with PU leather belt and handle to carry it easily. Composed by 6 pieces. Shaker's capacity: 700ml, Jigger Capacity: 35ml.

**FR Service à cocktail professionnel en acier inoxydable**, dans un étui en toile avec une sangle et une poignée en faux cuir pour un transport facile. Composé de 6 pièces. Contenance du shaker: 700ml, Contenance du jigger: 35ml.



**Cucchiaino**  
Long spoon  
Cuillère torsadée

**Shaker con filtro integrato**  
Shaker with integrated filter  
Shaker avec filtre intégré

**Pinza**  
Tongs  
Pince

**Pestello**  
Pestle  
Pilon

**Misurino**  
Jigger  
Doseur à cocktail

**Strainer**  
Strainer



*Facile trasporto*  
*Easy carry*  
*Facile à transporter*

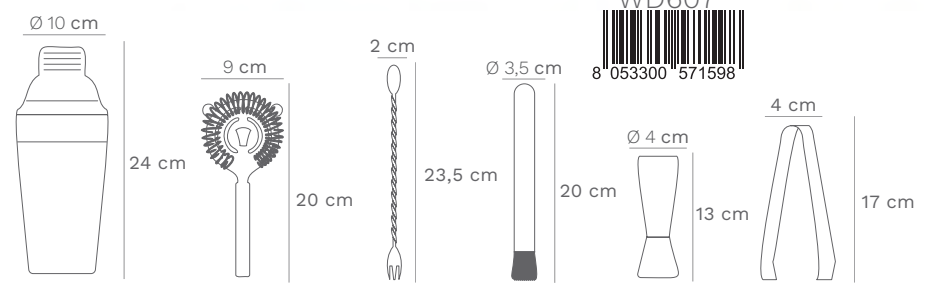

WD607  
8 053300 571598

- Sì lavastoviglie  
Dishwasher safe  
Lave-vaisselle possible
- No microonde  
No microwave  
Pas de micro-ondes

### WD579

**IT Sciabola da Sommelier con manico in legno e corda in raso.**

**EN Sommelier saber with wooden handle and satin cord.**

**FR Sabre de sommelier avec manche en bois et cordon en satin.**



WD579  
8 053300 570911

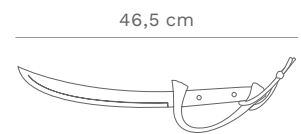

- No lavastoviglie  
No dishwasher  
Pas de lave-vaisselle
- No microonde  
No microwave  
Pas de micro-ondes



### WD424

**IT Set cocktail in acciaio inox con finitura rosegold** composto da: shaker (800ml), colino, misurino dosatore doppio, cucchiaio dosatore. Capacità Jigger: 35ml.

**EN Stainless steel cocktail set** with rosegold finishing composed of: shaker (800ml), jigger, strainer, spoon. Jigger Capacity: 35ml.

**FR Service à cocktail en acier inoxydable** avec finition or rose comprenant: un shaker (800ml), un strainer, une double tasse à mesurer, une cuillère à mesurer. Contenance du jigger: 35ml.



Si lavastoviglie  
Dishwasher safe  
Lave-vaisselle possible

No microonde  
No microwave  
Pas de micro-ondes

WD424  
8 033040 745350

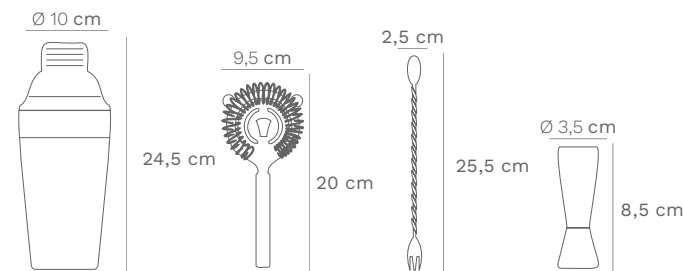

### WD572

**IT Set composto da Boston shaker e strainer.** Questo shaker professionale è completo di bicchiere in acciaio inox e bicchiere in vetro. Perfetto per realizzare cocktails deliziosi ed elaborati. Capacità: 800ml.

**EN Set consisting of Boston shaker and strainer.** This professional shaker is composed of a stainless steel container and a glass. Perfect for making delicious and elaborate cocktails. Capacity: 800ml.

**FR Ensemble composé d'un Boston shaker et d'un strainer.** Ce shaker professionnel est complet avec un gobelet en acier inoxydable et d'un verre. Parfait pour réaliser des cocktails délicieux et élaborés. Contenance: 800ml.



WD572  
8 053300 570508

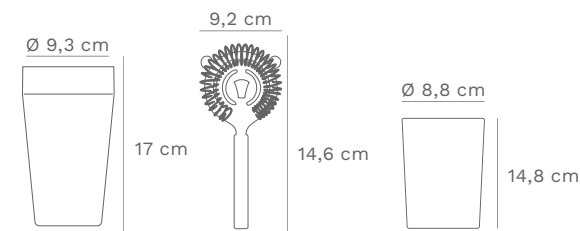

Si lavastoviglie  
Dishwasher safe  
Lave-vaisselle possible

No microonde  
No microwave  
Pas de micro-ondes

### WD573

**IT Cocktail shaker professionale da 800ml in acciaio inox, con filtro integrato.** Prepara dei cocktail professionali per le occasioni speciali a casa tua.

**EN 800ml professional cocktail shaker in stainless steel, with integrated filter.** Prepare professional cocktails for your special occasions at home.

**FR Shaker à cocktail professionnel de 800ml en acier inoxydable avec filtre intégré.** Préparez chez vous des cocktails professionnels pour les grandes occasions.



WD573  
8 053300 570515

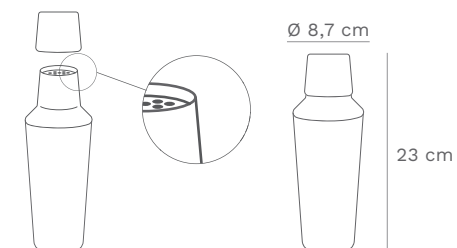



### WD480

**IT** Moscow Mule Mug in acciaio placcato rame con effetto martellato. Capacità 500ml.

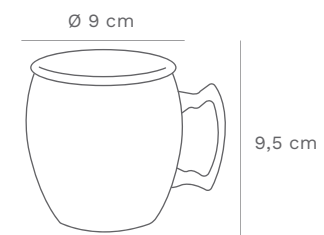

**EN** Moscow Mule Mug. Copper plated stainless steel mug with hammered finishing. Capacity 500ml.

**FR** Moscow Mule Mug en acier plaqué cuivre avec effet martelé. Contenance: 500ml.



WD480  
8 033040 746692



-  Si lavastoviglie  
Dishwasher safe  
Lave-vaisselle possible
-  No microonde  
No microwave  
Pas de micro-ondes

### WD523

**IT** Set 6 cannuce in acciaio inox riutilizzabili con scovolino.

**EN** Set 6 stainless steel reusable straws and cleaning brush.

**FR** Ensemble de 6 pailles réutilisables en acier inoxydable avec cure-pipe.



WD523N  
8 033040 748504





WD523R  
8 033040 748511



WD523S  
8 033040 748498



-  Si lavastoviglie  
Dishwasher safe  
Lave-vaisselle possible
-  No microonde  
No microwave  
Pas de micro-ondes



Legno FSC  
FSC wood  
Bois FSC



**WD591**

**IT** Tagliere in legno di acacia FSC®, con ricetta cocktail incisa. Manico con foro e cordino per aggancio. Dimensioni: 29,5x15cm.

**EN** FSC® acacia wood cutting board, with engraved cocktail recipe. Handle with hole and cord for hooking. Dimensions: 29.5x15cm.

**FR** Planche à découper en bois d'acacia FSC®, avec recette de cocktail gravée. Poignée avec trou et cordon d'attache. Dimensions: 29,5x15cm.



**WD593**

**IT** Tagliere in legno di acacia FSC®, con ricetta cocktail incisa. Manico con foro e cordino per aggancio. Dimensioni: 40,8x17cm.

**EN** FSC® acacia wood cutting board, with engraved cocktail recipe. Handle with hole and cord for hooking. Dimensions: 40.8x17cm.

**FR** Planche à découper en bois d'acacia FSC®, avec recette de cocktail gravée. Poignée avec trou et cordon d'attache. Dimensions: 40,8x17cm.



- No lavastoviglie  
No dishwasher  
Pas de lave-vaisselle
- No microonde  
No microwave  
Pas de micro-ondes

**LEGNO DI ACACIA  
DALL'ISOLA DI HAINAN**

Il legno di acacia di questo tagliere proviene dall'isola di Hainan. Un'isola del sud della Cina, di origine vulcanica, presenta spiagge basse contraddistinte da una sabbia finissima di color bianco, e una lussureggiante vegetazione di tipo subtropicale intatta. L'isola ospita una vasta area di coltivazioni di Acacia Mangium. Questo albero cresce molto velocemente e può arrivare fino a 20 m.

La certificazione FSC® attesta la provenienza DEL LEGNO da foreste che rispettano rigorosi standard ambientali, sociali ed economici.

**ACACIA WOOD  
FROM THE HAINAN ISLAND**

The acacia wood of this cutting board comes from the Hainan island. An island in southern China, of volcanic origin, characterized by low beaches with very fine white sand, and by a lush, intact subtropical vegetation. The island is home to a large area of Acacia Mangium cultivation. This tree grows very fast and can reach up to 20 m height.

The FSC® certification certifies the origin OF WOOD from forests that respect rigorous environmental, social and economic standards.

**BOIS D'ACACIA  
DE L'ÎLE DE HAINAN**

Le bois d'acacia utilisé pour cette planche à découper provient de l'île de Hainan. Cette île volcanique du sud de la Chine possède des plages peu profondes de sable blanc et fin et une végétation subtropicale luxuriante et préservée. L'île abrite une grande zone de culture d'Acacia Mangium. Cet arbre pousse très vite et peut atteindre jusqu'à 20 m de haut.

La certification FSC® atteste que le bois provient de forêts qui respectent des normes environnementales, sociales et économiques strictes.



**WD592**

**IT** Tagliere in legno di acacia FSC®, con ricetta cocktail incisa. Manico con foro e cordino per aggancio. Dimensioni: 31,6x24,6cm.

**EN** FSC® acacia wood cutting board, with engraved cocktail recipe. Handle with hole and cord for hooking. Dimensions: 31.6x24.6cm.

**FR** Planche à découper en bois d'acacia FSC®, avec recette de cocktail gravée. Poignée avec trou et cordon d'attache. Dimensions: 31,6x24,6cm.



**WD594**

**IT** Tagliere in legno di acacia FSC®, con ricetta cocktail incisa. Manico con foro e cordino per aggancio. Dimensioni: 50x13cm.

**EN** FSC® acacia wood cutting board, with engraved cocktail recipe. Handle with hole and cord for hooking. Dimensions: 50x13cm.

**FR** Planche à découper en bois d'acacia FSC®, avec recette de cocktail gravée. Poignée avec trou et cordon d'attache. Dimensions: 50x13cm.

## SIENA LINE



## WD571

**IT Sacchetto per pane in 100% cotone.** Con cuscino contenente semi di ciliegio per preservare il calore del pane appena sfornato o per servirlo in tavola caldo. Per un corretto utilizzo riscaldare il cuscino in microonde per massimo 2 minuti a potenza media, chiudere la zip per ottenere un calore più duraturo. Non riscaldare nel forno. Non scaldare il sacchetto nel microonde.

**EN Bread bag in 100% cotton.** With pillow containing cherry seeds to preserve the warmth of freshly baked bread or to serve it hot. For a correct use, heat the pillow in the microwave for maximum 2 minutes at medium power, close the zip to obtain a longer lasting heat. Do not heat in the oven. Do not heat the bag in the microwave.

**FR Sac à pain 100% coton.** Avec coussin contenant des graines de cerisier pour préserver la chaleur du pain fraîchement cuit ou pour le servir chaud à table. Pour une utilisation correcte, chauffez le coussin au micro-ondes pendant 2 minutes maximum à puissance moyenne, fermez le zip pour obtenir une chaleur plus durable.



WD571BE



8 053300 570447



WD571BL



8 053300 577781



WD571G



8 053300 570478



WD571N



8 053300 577774



WD571R



8 053300 570461



WD571V



8 053300 570454

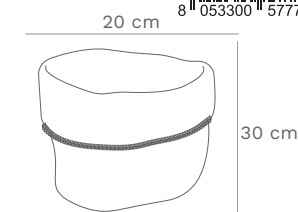

Lavare a mano  
Hand wash  
Lavage des mains



WD571DECR



8 053300 572786



WD571DECV



8 053300 572793



WD571DECG



8 053300 577248



WD571DECO



8 053300 577941



Lavare a mano  
Hand wash  
Lavage des mains

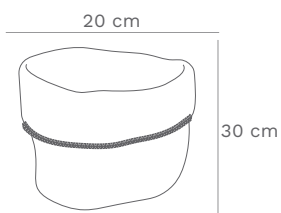

Sacchetto in 100% cotone.  
Bag in 100% cotton.  
Sac 100% coton.

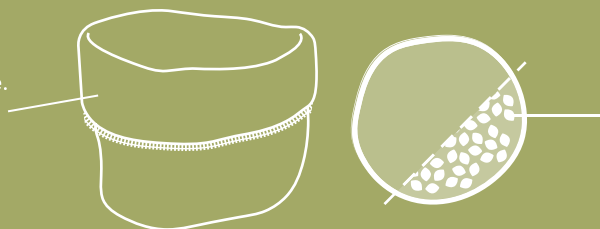

Cuscino in 100% cotone riempito con semi di ciliegio.  
Pillow in 100% cotton filled with cherry seeds.  
Cussion en 100% coton, rempli de noyaux de cerises.



**IT** Estrarre il cuscino con i semi di ciliegio.  
**EN** Take out the pillow with the seeds.  
**FR** Extraire le coussin en noyaux de cerises.



**IT** Riscaldare in microonde per max 2 min.  
**EN** Heat in the microwave for max 2 min.  
**FR** Le réchauffer au micro-ondes pendant 2 minutes max.



**IT** Riporre il cuscino all'interno del sacchetto.  
**EN** Place the pillow inside the bag.  
**FR** placez le coussin à l'intérieur du sac.



**IT** Inserire il pane per mantenerlo caldo.  
**EN** Insert the bread to keep it warm.  
**FR** Déposer le pain dans la corbeille.

## WD577

**IT Oliera/Acetiara in vetro borosilicato.** Con beccuccio anti-goccia per dosare correttamente l'olio o l'aceto nelle tue pietanze. La sabbiatura sul collo permette una chiusura ermetica e una perfetta tenuta evitando gocciolamenti. Grazie alle proprietà del vetro borosilicato è molto resistente ed allo stesso tempo particolarmente trasparente e leggera.

**EN With anti-drip spout to correctly dose the oil or vinegar in your dishes.** The sandblasting on the neck allows a hermetic closure and a perfect seal avoiding any dripping. Thanks to the properties of borosilicate glass, this oil / vinegar bottle is very resistant and at the same time particularly transparent and light.

**FR Huilier/Vinaigrier en verre borosilicate.** Avec bec verseur anti-goutte pour doser correctement l'huile ou le vinaigre dans vos plats. Le sablage du col permet une fermeture hermétique et une étanchéité parfaite évitant les coulures. Les propriétés du verre borosilicate permettent d'avoir des produits légers, transparents et très résistants.

Boy Scout



WD577B



8 053300 570690



Classica



WD577C



8 053300 570713



Fiaschetta



WD577F



8 053300 570683



Tanica





WD577T



8 053300 570706



-  Becco antigoccia  
Anti-drip spout  
Bec anti-goutte
-  Si lavastoviglie  
Dishwasher safe  
Lave-vaisselle possible
-  Si microonde  
Microwave safe  
Micro-ondes possible

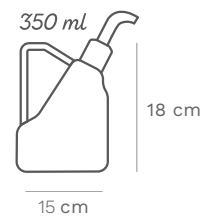
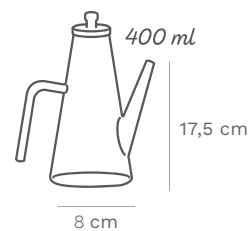
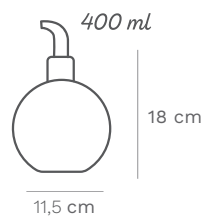

## WD586

**IT Set 6 bicchieri in vetro borosilicato decorati con 6 diversi aforismi.** Grazie alle proprietà del vetro borosilicato questi bicchieri sono molto resistenti e allo stesso tempo particolarmente trasparenti e leggeri. Capacità: 300ml.

**EN Set composed by 6 borosilicofed glasses decorated with 6 different quotes.** Thanks to the properties of borosilicate glass, these glasses are very resistant and at the same time particularly transparent and light. Capacity: 300ml.

**FR Ensemble de 6 verres à eau en verre borosilicate décorés de 6 aphorismes différents.** Grâce à la propriété du verre borosilicate, ces verres sont très durables et en même temps particulièrement transparents et légers. Capacité: 300ml.



Acqua



Bevimi



Fresca



Frizzante



Mezzo pieno





Naturale

WD586

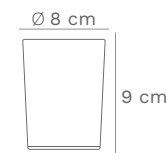

8 053300 571321



-  Si lavastoviglie  
Dishwasher safe  
Lave-vaisselle possible
-  Si microonde  
Microwave safe  
Micro-ondes possible



# MILANO LINE



## WD770 LOFT LAMP

**IT** Lampada da comodino. Il design moderno e colorato rende ogni ambiente della tua casa originale.

**EN** Bedside lamp. Its modern and colorful design makes every room in your house unique.

**FR** Lampe de chevet. Son design moderne et coloré rend chaque pièce de votre maison unique.



WD770AR  
8 053300 578351











WD770B  
8 053300 578344



WD770BL  
8 053300 577613



WD770N  
8 053300 577620

-  Ricaricabile con entrata USB tipo C. Alimentatore non incluso.  
Rechargeable with USB port Type-C. Power supply not included.  
Rechargeable avec entrée USB Type-C. Alimentation non incluse.
-  Durata potenza min 36h/max 4h  
Power duration min 36h/max 4h  
Durée puissance min 36h/max 4h
-  Luce LED/LED light/Lumière LED  
 3 diverse potenze di luminosità  
 3 different powers of brightness  
 3 pouvoirs de luminosité différents
-  Accensione touch  
Turning touch  
Allumage par contact
-  PROTEZIONE IP44Protezione dalla polvere e dagli schizzi d'acqua  
IP44 PROTECTION Protection from dust and water splashes  
 PROTECTION IP44 contre la poussière et les projections d'eau

*Tempo di ricarica 4h*  
*Charging time 4h*  
*Temps de charge 4h*

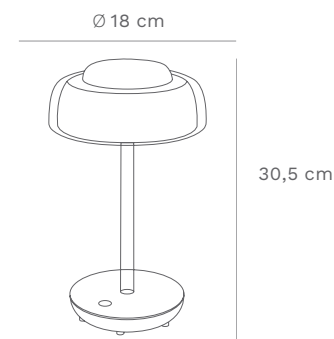

## WD660 HYGGE

**IT Lampada da tavolo portatile ricaricabile tramite entrata USB.** Dotata di pulsante di accensione touch e luce dimmerabile da 5% a 100% di luminosità. Luce a LED alimentata da batteria al litio 1800mAh con durata a potenza massima di 6 ore, tempo di ricarica 4 ore. Utilizzabile anche in ambienti esterni, protezione IP44. Potenza 5.5W.

**EN Portable table lamp rechargeable via USB input.** It features a touch power button and dimmable light from 5% to 100% brightness. LED light powered by 1800mAh lithium battery with maximum power life of 6 hours, charging time 4 hours. It can also be used outdoors, IP44 protection. Power 5.5W.

**FR Lampe de table portable et rechargeable via une entrée USB.** Elle dispose d'un bouton d'alimentation tactile et lumière gradable de 5% à 100% de luminosité. La lumière LED est alimentée par batterie au lithium 1800mAh avec une durée maximale de 6 heures, temps de charge 4 heures. Utilisable aussi en extérieur, protection IP44. Puissance 5.5W.



Ø 18 cm

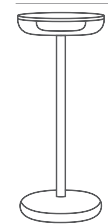

30,5 cm



- Ricaricabile con entrata USB alimentatore non incluso
- Rechargeable with usb input power supply not included
- Rechargeable avec entrée USB alimentation non incluse
- Luce LED/LED light/Lumière LED dimmerabile gradualmente
- gradually dimmable
- réglable progressivement



- Accensione touch
- Turning touch
- Allumage par contact



- Entrata USB tipo C
- Entrée USB Type-C
- Type-C port



- Durata potenza min 50h/max 6h
- Durée puissance min 50h/max 6h
- Power duration min 50h/max 6h



- PROTEZIONE IP44
- Protezione dalla polvere e dagli schizzi d'acqua

- IP44 PROTECTION
- protection from dust and water splashes

- PROTECTION IP44
- contre la poussière et les projections d'eau



## WD537 DINER LAMP



**IT** Lampada da tavolo portatile ricaricabile tramite entrata USB. Con tre diverse potenze di luminosità, ad accensione touch immediata. Luce a LED. Durata alla potenza minima 50h, durata alla potenza massima 7h, tempo di ricarica 7h. La lampada può essere utilizzata sia all'interno che all'esterno grazie al grado di protezione IP54. Potenza: 7.5W.

**EN** Portable table lamp, rechargeable through USB cable. With three different brightness levels and touch switch. Led light. Battery lasts up to 50h at minimum level and up to 7h at maximum level. Charging time 7h. The lamp can be used inside and outside thanks to the protection rating IP54. Power: 7.5W.

**FR** Lampe de table sans fil et rechargeable. Ampoule LED de puissance 7.5W. Interrupteur tactile. Trois niveaux de luminosité. Recharge par prise type USB. Durée de la charge: 50h d'éclairage en puissance minimale et 7h d'éclairage en puissance maximale. Temps de recharge: 7h. Utilisation en intérieur et extérieur, norme IP54.



- Ricaricabile con entrata USB, alimentatore non incluso
- Rechargeable with usb input, power supply not included
- Rechargeable avec entrée USB, alimentation non incluse



- Luce LED/LED light/Lumière LED
- 3 diverse potenze di luminosità
- 3 different powers of brightness
- 3 pouvoirs de luminosité différents



- Accensione touch
- Turning touch
- Allumage par contact



- Durata potenza min 50h/max7h
- Power duration min 50h/max7h
- Durée puissance min 50h/max7h



PROTEZIONE IP54  
Protezione dalla polvere e dagli schizzi d'acqua

IP54 PROTECTION  
Protection from dust and water splashes

PROTECTION IP54  
Contre la poussière et les projections d'eau

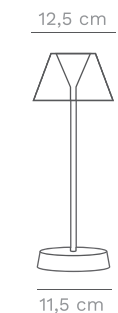

12,5 cm

11,5 cm

34 cm

*Tempo di ricarica 7H*

*Charging time 7H*

*Temps de charge 7H*



WD537CA



8° 053300° 573172°



WD537PA



8° 053300° 573165°



WD537SEN



8° 053300° 570621°



WD537MAT



8° 053300° 572557°



WD537G



8° 053300° 570775°

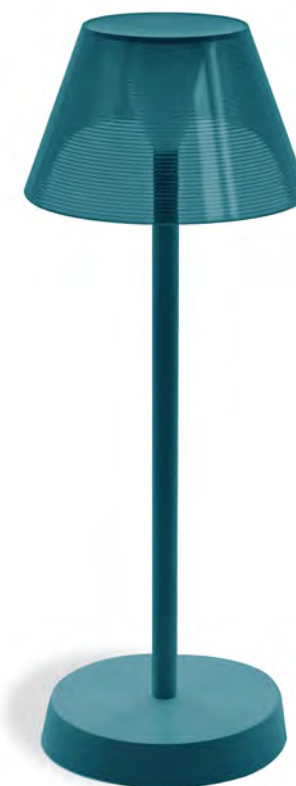

WD537PET



8° 053300° 570782°

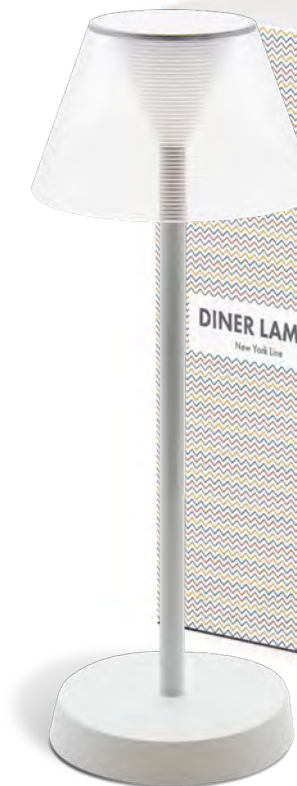

WD537B



8° 033040° 749310°



WD537N



8° 033040° 749303°

**WD641**

**IT** Caricatore Multiplo 8 porte USB (di cui 1 con tecnologia Quick Charger 3.0). Con schermo a LED per visualizzare i dati di carica, dotato di presa.

**EN** 8 USB port charger (with 1 port in Quick Charger 3.0 technology), with LED display to check the charging data and plug.

**FR** Chargeur multiple 8 ports USB (dont 1 technologie Quick Charger 3.0) avec écran LED pour afficher les données de charge, équipé d'une prise de courant.

*Ideale per ricaricare 8 lampade contemporaneamente!*

*Ideal for charging 8 lamps at the same time!*

*Idéal pour recharger 8 lampes en même temps!*



13 cm



6,5 cm

**WD581 ROOFTOP**

**IT ROOFTOP è un secchiello ghiaccio con altoparlante Bluetooth e lampada LED.** La tecnologia Bluetooth ti consente di riprodurre la tua musica preferita mentre il tuo vino/le tue bevande si mantengono fresche e la luce LED crea un'atmosfera unica. Puoi utilizzarlo ovunque grazie alla batteria ricaricabile che lo rende portatile e alla protezione da acqua e polvere. Possibilità di connessione simultanea ad un altro ROOFTOP.

**EN ROOFTOP is a Wine Cooler with Bluetooth speaker and LED lamp.** Bluetooth technology allows you to play your favourite music, while your wine or drinks stay cool and the LED light creates a unique atmosphere. You can use it in any place thanks to the rechargeable battery which makes it portable and the protection from water and dust. It can be connected simultaneously to another ROOFTOP.

**FR ROOFTOP est un seau à glace avec haut-parleur Bluetooth et lampe LED.** La technologie Bluetooth vous permet de diffuser votre musique préférée tout en gardant votre vin ou vos boissons fraîches, et la lumière LED crée une ambiance unique. Vous pouvez l'utiliser partout grâce à la batterie rechargeable qui le rend portable et à la protection contre l'eau et la poussière. Possibilité de connexion simultanée avec un autre ROOFTOP.

*Tempo di ricarica 4-6H*  
*Charging time 4-6H*  
*Temps de charge 4-6H*

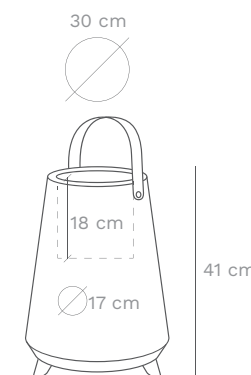

WD581



8 053300 570799



Speaker Bluetooth  
Bluetooth speaker



Secchiello ghiaccio  
Wine cooler  
Seau à glace



Luce dimmerabile  
Dimmable light  
Lumière à gradation



Luce LED 16 colori  
16-color LED light  
Lumière LED 16 couleurs



Cavo USB  
USB cable  
Cable USB



Resistente alla polvere  
Resistant to dust  
É tanche à la poussière



Controllo remoto  
Remote control  
Contrôle à distance



Luce ritmica  
Rhythmic light  
Lumière rythmique



Connessione simultanea  
Connexion simultanée  
Simultaneous connection



### WD769

**IT Caminetto centro tavola.** Elegante e moderno, perfetto per donare calore all'atmosfera. Da utilizzare con bioetanolo, non crea vapori dannosi o odori sgradevoli. Bioetanolo non incluso. Utilizzabile sia all'interno sia all'esterno.

**EN Centerpiece fireplace.** Elegant and modern, perfect for adding warmth to the atmosphere. To be used with bioethanol, it does not produce harmful vapors or unpleasant odors. Bioethanol not included. Suitable for both indoor and outdoor use.

**FR Cheminée de table.** Élégante et moderne, parfaite pour apporter de la chaleur à l'atmosphère. À utiliser avec du bioéthanol, ne crée pas de vapeurs nocives ni d'odeurs désagréables. Bioéthanol non inclus. Utilisable à l'intérieur comme à l'extérieur.



WD769B



WD769CA



WD769N



WD769PET

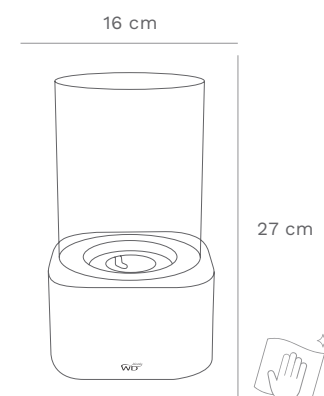

Lavare con un panno umido  
Wash with a damp cloth  
Laver avec un chiffon humide

### WD708

**IT Caminetto centrotavola o d'arredo.** Elegante e moderno, perfetto per donare calore all'atmosfera. Da utilizzare con bioetanolo, non crea vapori dannosi o odori sgradevoli. Bioetanolo non incluso. Utilizzabile sia all'interno sia all'esterno.

**EN Elegant and modern fireplace as centrepiece or ornamental,** perfect for adding warmth to the atmosphere. To be used with bioethanol, it does not create harmful vapours or unpleasant odours. Suitable for both indoor and outdoor use.

**FR Cheminée pièce maîtresse ou décorative élégante et moderne,** parfaite pour ajouter de la chaleur à l'atmosphère. À utiliser avec du bioéthanol, ne crée pas de vapeurs nocives ou d'odeurs désagréables. Peut être utilisé à l'intérieur comme à l'extérieur.



WD708B  
8 053300 575619

WD708N  
8 053300 575602

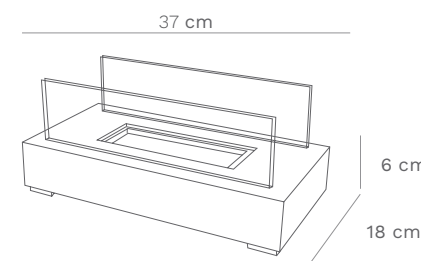

 Lavare con un panno umido  
Wash with a damp cloth  
Laver avec un chiffon humide



# HONG KONG LINE

## WD658

**IT Bilancia digitale colorata ultraslim.** Il design moderno e colorato dona originalità alla tua cucina. La bilancia di precisione misura oltre al peso (due unità di peso g e libbre convertibili), anche il volume dell'acqua e del latte (due unità di misura convertibili ml e fl oz). Sensibilità al grammo (1g) con portata massima di 10kg.

**EN Digital scale, colorful and ultraslim.** This modern and colorful design gives originality to your kitchen. The precision balance measures both the weight (two units of weight g and pounds, convertible) and the volume of water and milk (two units of measurement ml and fl oz, convertible). Gram sensitivity (1g) with a maximum load of 10kg.

**FR Balance numérique colorée ultraslim.** Le design moderne et coloré donne de l'originalité à votre cuisine. La balance de précision mesure non seulement le poids (deux unités de poids g et livres convertibles), mais aussi le volume de l'eau et du lait (deux unités de mesure convertibles ml et fl oz). Sensibilité au gramme (1g) avec charge maximale de 10kg.

 *Caricatore USB ricarica in 2H*  
*USB charger charging in 2H*  
*chargeur USB recharge en 2H*

 **MAX 10 kg**

 *Impermeabile!*  
*Waterproof!*  
*Imperméable!*



WD658AR  
  
8 053300 573608

WD658AZ  
  
8 053300 573622



WD658BL  
  
8 053300 573639

WD658GI  
  
8 053300 573615

 **Modalità tara**  
**Tare mode**  
**Mode tare**

 **Modalità volume acqua**  
**Water volume mode**  
**Mode volume d'eau**

 **MAX 10 kg**  
**Scarto 1 g**  
**Margin of error 1 g**  
**Marge d'erreur 1 g**

 **Modalità volume latte**  
**Milk volume mode**  
**Mode volume de lait**

 **PROTEZIONE IP67**  
**Protezione dalla polvere e dall'acqua**

 **IP67 PROTECTION**  
**protection from dust and water splashes**

 **PROTECTION IP67**  
**contre la poussière et les projections d'eau**

## WD659

**IT Bilancia digitale compatta.** Il design moderno e colorato dona originalità alla tua cucina. La bilancia di precisione misura sia il peso (due unità di peso g e libbre convertibili) sia il volume di acqua e latte (due unità di misura convertibili ml e fl oz). Sensibilità al grammo (1g) con portata massima di 5Kg.

**EN Compact digital scale.** This modern and colorful design gives originality to your kitchen. The precision balance measures both the weight (two units of weight g and pounds, convertible) and the volume of water and milk (two units of measurement ml and fl oz, convertible). Gram sensitivity (1g) with a maximum load of 5kg.

**FR Balance numérique compacte.** Le design moderne et coloré donne de l'originalité à votre cuisine. La balance de précision mesure à la fois le poids (deux unités de poids g et livres convertibles) et le volume d'eau et de lait (deux unités de mesure convertibles ml et fl oz). Sensibilité au gramme (1g) avec charge maximale de 5kg.

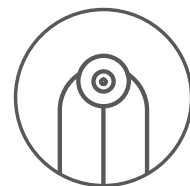

*Compatta e pensile!*  
*Compact and hanging!*  
*Compact et suspendu !*



WD659AR



8 053300 573646



WD659AZ



8 053300 573677



WD659R



8 053300 573660



WD659VE



8 053300 573653

7,5 cm

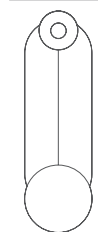

23 cm



Modalità tara  
Tare mode  
Mode tare



Modalità volume acqua  
Water volume mode  
Mode volume d'eau



1500 mAh battery



MAX 5kg  
Scarto 1g  
Margin of error 1g  
Marge d'erreur 1g



Modalità volume latte  
Milk volume mode  
Mode volume de lait

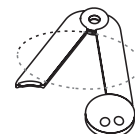

Zona di pesatura  
Weighing area  
Zone de pesage effective

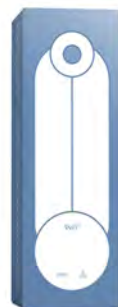

## KAFFA LINE

## WD498

**IT** Cappuccinatore elettrico pratico e versatile per preparare una deliziosa schiuma di latte densa e cremosa in pochi secondi. Realizzato in vetro borosilicato con inserti in finitura opaca nera. Recipiente in vetro. Il cappuccinatore può scaldare il latte e creare una schiuma come al bar. Diversamente, senza azionare la modalità riscaldante, può essere preparata una schiuma fredda. Tasto on/off e doppio clic per modalità caldo con indicatore a luce led rossa. Funzionamento ad induzione. Indicatore di livello MIN e MAX sul recipiente. Potenza: 600W

**EN** Practical and versatile electric milk frother for preparing delicious, dense, and creamy milk foam in seconds. Made of borosilicate glass with matte black finish inserts. Glass container. The milk frother can heat the milk and create foam like at a coffee bar. Alternatively, without activating the heating mode, cold foam can be prepared. On/off button and double click for hot mode with red LED light indicator. Induction operation. MIN and MAX level indicators on the container. Power: 600W.

**FR** Mousseur à lait électrique pratique et polyvalent pour préparer une mousse de lait délicieuse, dense et crémeuse en quelques secondes. Fabriqué en verre borosilicate avec des inserts en finition noire mate. Récipient en verre. Le mousseur à lait peut chauffer le lait et créer une mousse comme au café. Alternativement, sans activer le mode chauffant, une mousse froide peut être préparée. Bouton on/off et double clic pour le mode chaud avec indicateur à lumière LED rouge. Fonctionnement par induction. Indicateurs de niveau MIN et MAX sur le récipient. Puissance : 600W.



WD498



8 033040 747439



Mod. montatura a caldo  
Hot froth mode  
Mode de montage à chaud



Testina per montare  
Frothing whisk  
Tête de montage



Mod. montatura a freddo  
Cold froth mode  
Mode de montage à froid



Testina per scaldare  
Heating whisk  
Tête de chauffage

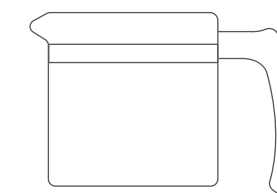

BROCCA | PITCHER | CARAFE



Si lavastoviglie  
Dishwasher safe  
Lave-vaisselle possible



No microonde  
No microwave  
Pas de micro-ondes

## WD496

**IT Bollitore elettrico in vetro borosilicato con inserti in finitura opaca.** Dotato di display che segnala la temperatura dell'acqua. Grazie alla possibilità di impostare i gradi, questo è il prodotto ideale per la preparazione di alcune tipologie di tè, dove l'acqua necessita di essere portata ad una determinata temperatura. Le luci led cambiano di colore al raggiungimento delle varie temperature. Base con salvaspazio per il cavo. Bollitore ruotante a 360° su base. Capacità:1,7L. Potenza: 1850-2200W.

**EN Electric kettle in borosilicate glass with matt finish inserts.** Equipped with a display that shows the water temperature. Thanks to the possibility of setting the degrees, it is the ideal product for the Preparation of some types of tea, in which the water needs to be brought a certain temperature. The LED lights change color when the various temperatures are reached. Base with space-saving cable. 360 ° rotating kettle on the base.Capacity: 1,7L. Power: 1850-2200W.

**FR Bouilloire électrique en verre borosilicate avec inserts en finition mate.** Équipé d'un écran qui indique la température de l'eau. Grâce à la possibilité de régler les degrés, c'est le produit idéal pour la préparation de certains types de thé, où l'eau doit être portée à une certaine température. Les lumières LED changent de couleur lorsque les différentes températures sont atteintes. Base avec économiseur d'espace pour le câble. La bouilloire tourne à 360° sur la base. Contenance: 1,7L. Puissance: 1850-2200W.



WD496



8 033040 747415

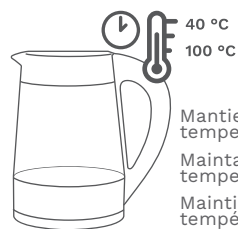

Mantiene la temperatura  
Maintaining the temperature  
Maintien de la température

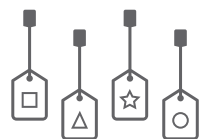

Temperature differenti per tè differenti  
Different temperatures for different teas  
Différentes températures pour différents thés



SENZA BISFENOLO  
WITHOUT BISPENOL  
SANS BISPHÉNOL



16 colorazioni LED  
16-color LED light  
Lumière LED 16 couleurs



No lavastoviglie  
No dishwasher  
Pas de lave-vaisselle



No microonde  
No microwave  
Pas de micro-ondes



## PECHINO LINE

WD789 *New*

**IT Set 6 tazzine da caffè con piattino.** Perfetto per iniziare la tua giornata con un tocco di originalità e gusto. Scegli la combinazione che più preferisci. Capacità: 100ml

**EN Set of 6 coffee cups with saucers.** Perfect for starting your day with a touch of originality and style. Choose the combination you prefer. Capacity: 100ml

**FR Set de 6 tasses à café avec soucoupes.** Idéal pour commencer votre journée avec une touche d'originalité et de style. Choisissez la combinaison que vous préférez. Contenance : 100 ml



WD789



8 053300 579518

Ø 6,5 cm



9,5 cm



Si lavastoviglie  
Dishwasher safe  
Lave-vaisselle possible



Si microonde  
Microwave safe  
Micro-ondes possible



### WD698

**IT Set 6 coppette decorate.** Esterno decorato con texture ed interno monocolore. Perfette per servire il dessert donando uno stile orientale alla tua tavola. Materiale: ceramica. Capacità: 300ml.

**EN Set of 6 decorated cups.** External part with print design, internal part in solid colour. Recommended to serve the dessert giving an oriental style to your table. Material: ceramic. Capacity: 300ml.

**FR Set de 6 bols décorés.** Extérieur texturé et intérieur unicolore. Parfait pour servir un dessert en donnant un style oriental à votre table. Matière: céramique. Contenance: 300ml.



WD698  
8 053300 575350



Si lavastoviglie  
Dishwasher safe  
Lave-vaisselle possible

Si microonde  
Microwave safe  
Micro-ondes possible

### WD699

**IT Set 3 vassoi rettangolari in 3 misure e 3 decorazioni differenti.** Pratico e colorato set di vassoi per servire thé, aperitivi e caffè donando un tocco orientale alla vostra tavola. Grazie ai ricercati decori questo articolo diventa un elemento decorativo per la tua casa. Materiale: ceramica.

**EN Set of 3 rectangular tray in 3 sizes and 3 different decorations.** Practical and colourful set of trays for serving tea, aperitifs and coffee giving an oriental touch to your table. Thanks to the refined decorations this article is also a decorative element for your house.

**FR Set de 3 plateaux rectangulaires en 3 tailles et 3 décorations différents.** Set de plateaux pratiques et colorés pour servir le thé, les apéritifs et le café en donnant une touche orientale à votre table. Grâce aux décorations raffinées, cet article devient un élément décoratif pour votre maison. Matière: céramique.

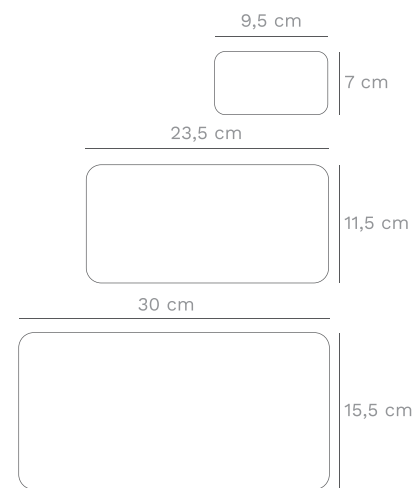

WD699  
8 053300 575367

Si lavastoviglie  
Dishwasher safe  
Lave-vaisselle possible

Si microonde  
Microwave safe  
Micro-ondes possible



### WD700

**IT Set 2 coppette decorate a rilievo, 2 bacchette e 2 poggia bacchette.** Questo set in perfetto stile asiatico, ti consente di dare originalità e colore ai tuoi piatti orientali. Materiale: ceramica. Capacità: 300ml.

**EN Set of 2 cups decorated in relief, 2 chopsticks and 2 chopstick rests.** This set in perfect Asian style allows you to add originality and color to your oriental dishes. Material: ceramic. Capacity: 300ml.

**FR Set de 2 bols décoration en relief, 2 baguettes et 2 porte-baguettes.** Ce set au style asiatique vous permet d'ajouter de originalité et de la couleur à vos plats orientaux. Matière: céramique. Contenance: 300ml.



WD700A  
8 053300 575374



WD700B  
8 053300 575527



WD700C  
8 053300 578177

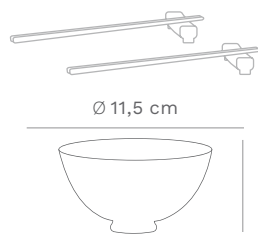

- Si lavastoviglie  
Dishwasher safe  
Lave-vaisselle possible
- Si microonde  
Microwave safe  
Micro-ondes possible

### WD701

**IT Kit 2 piattini e 2 ciotoline decorate a rilievo, 2 bacchette e 2 poggia bacchette.** Questo kit in perfetto stile asiatico, ti consente di portare originalità e autenticità ai tuoi piatti orientali. Materiale: ceramica.

**EN Kit consisting of 2 plates and 2 saucers with embossed decorations, 2 chopsticks and 2 chopstick holders.** This kit in perfect Asian style allows you to serve your oriental dishes with originality and authenticity. Material: ceramic.

**FR Set de 2 petites assiettes carrées et 2 petites coupelles avec décoration relief.** Fournie avec 2 baguettes et 2 porte-baguettes. Ce kit au style asiatique vous permet d'apporter originalité et authenticité à vos plats orientaux. Matière: céramique.



WD701A  
8 053300 575381



WD701B  
8 053300 575398



WD701C  
8 053300 578184

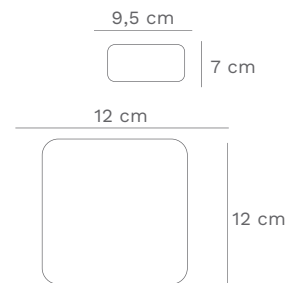

- Si lavastoviglie  
Dishwasher safe  
Lave-vaisselle possible
- Si microonde  
Microwave safe  
Micro-ondes possible



**WD702**

**IT Set 2 ciotole Ramen con decorazione a rilievo corredato da 2 coppie di bacchette.** Questo set è perfetto per dare un tocco di originalità alle tue combinazioni Poke, Ramen e Noodles. Materiale: ceramica. Capacità: 800ml.

**EN Set composed of 2 bowls with embossed decorations and 2 chopstick pairs.** Ideal for ramen, poke and noodles. This set is perfect to give originality to your oriental dishes. Material: ceramic. Capacity: 800ml.

**FR Ensemble de 2 bols à Ramen avec décoration en relief accompagnés de 2 paires de baguettes.** Ce set est parfait pour ajouter une touche d'originalité à vos combinaisons de Poke, Ramen et Noodles. Matière: céramique. Contenance: 800ml.



WD702A



8 053300 575404

WD702B



8 053300 578191

WD702C



8 053300 578207

Ø 14 cm

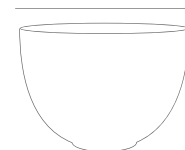

11,5 cm



Si lavastoviglie  
Dishwasher safe  
Lave-vaisselle possible



Si microonde  
Microwave safe  
Micro-ondes possible



### WD703

**IT Tazza in ceramica con decorazione.** Perfetta per dare un tocco di originalità al tuo momento del tè., scegli le combinazioni che più preferisci per donare colore alla tua tavola. Materiale: ceramica. Capacità: 360ml.

**EN Ceramic mug with decoration.** Perfect to give a touch of originality to your tea time. Choose your favourite combinations to add colour to your table. Material: ceramic. Capacity: 360ml.

**FR Tasse en céramique avec décoration.** Parfait pour donner une touche d'originalité à votre heure du thé. Choisissez vos combinaisons préférées pour ajouter de la couleur à votre table. Matière: céramique. Contenance: 360 ml.



WD703A



8 053300 575428



WD703B



8 053300 575596



WD703C



8 053300 575626



WD703D



8 053300 575633



Ø 9 cm



11 cm



Si lavastoviglie  
Dishwasher safe  
Lave-vaisselle possible



Si microonde  
Microwave safe  
Micro-ondes possible

### WD704

**IT Set teiera con manico in bamboo e 4 tazze decorate a rilievo.** Questo set in perfetto stile asiatico, ti consentirà di dare originalità e autenticità ai tuoi momenti di relax. Materiale: ceramica. Capacità teiera: 750ml. Capacità tazze: 160ml.

**EN Teapot set with bamboo handle and 4 relief decorated cups.** This set in perfect Asian style will allow you to give originality and authenticity to your moments of relaxation. Material: ceramic. Teapot capacity: 750ml. Cup capacity: 160ml.

**FR Ensemble théière avec 4 gobelets avec décoration relief.** Théière avec poignée bambou et filtre. Cet ensemble au style asiatique vous permettra de donner originalité et authenticité à vos moments de détente. Matière: céramique.



WD704A



8 053300 575435



WD704B



8 053300 575442

18 cm

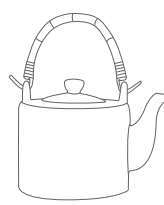

12 cm

7 cm



7 cm



Si lavastoviglie  
Dishwasher safe  
Lave-vaisselle possible



Si microonde  
Microwave safe  
Micro-ondes possible

Togliere il manico prima di  
inserire in lavastoviglie

Remove the handle before  
placing in the dishwasher

Retirer la poignée avant de  
mettre au lave-vaisselle



### WD705

**IT Set 4 piatti da dessert.** Questo set in perfetto stile asiatico ti consente di servire i tuoi dessert donando originalità e colore alla tua tavola. Materiale: ceramica.

**EN Set of 4 dessert plates.** This Asian-style set allows you to serve your desserts while bringing originality and colour to your table. Material: ceramic.



**FR Set de 4 assiettes à dessert.** Ce set au style asiatique vous permet de servir vos desserts tout en apportant originalité et couleur à votre table. Matière: céramique.

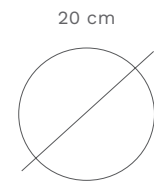

WD705  
8 053300 575459



20 cm

 Sì lavastoviglie  
Dishwasher safe  
Lave-vaisselle possible  
 Sì microonde  
Microwave safe  
Micro-ondes possible

### WD707

**IT Kit 2 set bacchette in legno con decoro e 2 poggia bacchette in ceramica.** Un kit colorato ed originale, perfetto come regalo ad amici e parenti ma anche per decorare ed abbellire la tua tavola.

**EN Set of 2 wooden chopsticks with decoration and 2 chopstick ceramic rests.** A colourful and original kit, perfect as a gift to friends and family but also to decorate and embellish your table.

**FR Set de 2 baguettes en bois avec décoration et 2 porte-baguettes en céramique.** Un kit coloré et original, idéal pour offrir aux amis et à la famille, mais aussi pour décorer et embellir la table.



WD707A  
8 053300 575473



WD707B  
8 053300 575015



WD707C  
8 053300 575480



WD707D  
8 053300 575534

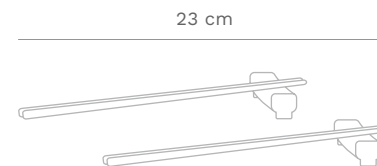

23 cm

 Lavare a mano  
Hand wash  
Lavage des mains





## WD609

**IT Set 6 coppette.** Con interno decorato lucido ed esterno monocolor matt. 6 decori e 6 colori diversi. Abbinabili alle tovagliette WD608. Materiale: ceramica. Capacità: 300ml.

**EN Set of 6 bowls,** glossy decorated interior and matt one-color exterior. With 6 different colors and decorations. Discover the different possible combinations with WD lifestyle placemats. Material: ceramic. Capacity: 300ml.

**FR Set de 6 bols.** Intérieur brillant décoré et Extérieur unicolore mat de 6 couleurs différentes. 6 décors et 6 couleurs différentes. Peut être combiné avec les napperons WD608. Matière: céramique. Contenance: 300ml.



-  Sì lavastoviglie  
Dishwasher safe  
Lave-vaisselle possible
-  Sì microonde  
Microwave safe  
Micro-ondes possible

## WD610

**IT Set di 3 vassoi rettangolari.** In 3 colori e decorazioni differenti. Interno decorato lucido ed esterno monocolor matt. Pratico ed elegante set di vassoi per servire tè, aperitivi e caffè donando un tocco orientale alla vostra tavola. Scopri i diversi possibili abbinamenti con le tovagliette WD lifestyle. Materiale: ceramica.

**EN Set of 3 rectangular trays** in 3 different colors and decorations. Glossy decorated interior and matt one-color exterior. Practical and elegant set of trays to serve tea, aperitifs and coffee giving an oriental touch to your table. Discover the different possible combinations with WD lifestyle placemats. Material: ceramic.

**FR Set de 3 plats rectangulaires.** Intérieur brillant décoré et Extérieur unicolore mat de 3 couleurs différentes. 3 tailles différentes. Ensemble pratique et élégant de plateaux pour servir le thé, les apéritifs et le café avec une touche orientale à votre table. Découvrez les différentes combinaisons possibles avec les sets de table WD lifestyle. Matière: céramique.

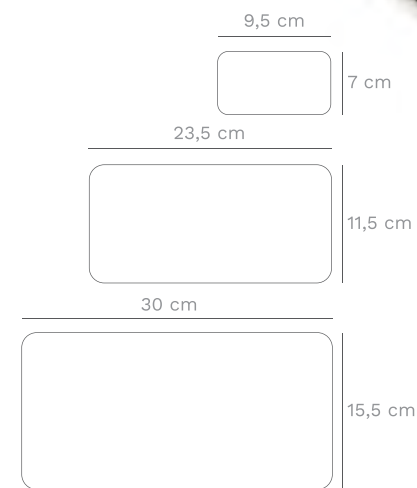

-  Sì lavastoviglie  
Dishwasher safe  
Lave-vaisselle possible
-  Sì microonde  
Microwave safe  
Micro-ondes possible



### WD611

**IT Set 2 ciotole Ramen in due diversi decori, con 2 paia di bacchette in PET.** Interno decorato lucido ed esterno monocolore matt. Questo set è perfetto per dare un tocco di originalità alle tue combinazioni Poke, Ramen e Noodles. Scopri i diversi possibili abbinamenti con le tovagliette WD lifestyle. Materiale: ceramica. Capacità: 800ml.

**EN Set of 2 Ramen bowls in two different decorations, with 2 pairs of PET chopsticks.** Glossy decorated interior and matt one-color exterior. This set is perfect for adding a touch of originality to your Poke, Ramen and Noodles combinations. Discover the different possible combinations with WD lifestyle placemats. Material: ceramic. Capacity: 800ml.

**FR Set de 2 bols à Ramen avec 2 baguettes en PET.** Intérieur brillant décoré et Extérieur unicolore mat de 2 couleurs différentes. Cet ensemble est parfait pour ajouter une touche d'originalité à vos combinaisons de Poke, Ramen et Noodles. Découvrez les différentes combinaisons possibles avec les napperons WD lifestyle. Matière: céramique. Contenance: 800ml.



- Si lavastoviglie  
Dishwasher safe  
Lave-vaisselle possible
- Si microonde  
Microwave safe  
Micro-ondes possible

### WD612

**IT Kit 2 piattini, 2 ciotoline, 2 paia di bacchette in PET e 2 poggia bacchette.** Con interno decorato lucido ed esterno monocolore matt. Questo kit in perfetto stile asiatico, ti consente di portare originalità e autenticità ai tuoi piatti orientali. Scopri i diversi possibili abbinamenti con le tovagliette WD lifestyle. Materiale: ceramica.

**EN Kit of 2 saucers, 2 bowls, 2 pairs of PET chopsticks and 2 chopsticks holders,** with glossy decorated interior and matt one-color exterior. This kit in perfect Asian style, allows you to bring originality and authenticity to your oriental dishes. Discover the different possible combinations with WD lifestyle placemats. Material: ceramic.

**FR Ensemble de 2 petits assiettes, 2 bols, 2 paires de baguettes en PET et 2 porte-baguettes.** Intérieur brillant décoré et Extérieur unicolore mat. Cet ensemble de style asiatique vous permet d'apporter originalité et authenticité à vos plats asiatiques. Découvrez les différentes combinaisons possibles avec les sets de table WD lifestyle. Matière: céramique.

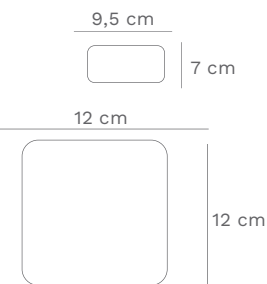

- Si lavastoviglie  
Dishwasher safe  
Lave-vaisselle possible
- Si microonde  
Microwave safe  
Micro-ondes possible



**WD613**

**IT Set 2 coppette, 2 paia di bacchette in PET e 2 poggia bacchette in due decorazioni differenti.** Interno decorato lucido ed esterno monocolor matt. Questo set in perfetto stile asiatico, consente di dare originalità e autenticità ai tuoi piatti orientali. Abbinabili alle tovagliette WD608. Materiale coppette: ceramica. Capacità: 300ml.

**EN Set of 2 bowls, 2 pairs of PET chopsticks and 2 chopsticks holders in two different decorations.** Glossy decorated interior and matt one-color exterior. This set in perfect Asian style, allows you to give originality and authenticity to your oriental dishes. Discover the different possible combinations with WD lifestyle placemats. Cup material: ceramic. Capacity: 300ml.

**FR Ensemble de 2 tasses, 2 paires de baguettes en PET et 2 porte-baguettes dans deux décorations différentes.** Intérieur brillant décoré et Extérieur unicolore mat. Cet ensemble de style asiatique vous permet d'apporter originalité et authenticité à vos plats asiatiques. Matière: céramique. Peut être combiné avec les napperons WD608. Matériau de la tasse: céramique. Contenance: 300 ml.



WD613AZ  
8°053300°571727

WD613F  
8°053300°571710

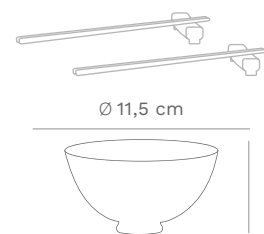

Si lavastoviglie  
Dishwasher safe  
Lave-vaisselle possible

Si microonde  
Microwave safe  
Micro-ondes possible



# OSAKA LINE



## WD771

**IT Teiera in ghisa 1L.** Dal design moderno e dai colori brillanti, rende la tua cucina e la tua tavola originale. La ghisa permette un'ottima conduzione del calore e lo preserva per diverse ore. Si consiglia di togliere il filtro in acciaio durante la bollitura ed utilizzare uno spargi fiamma da interporre tra la teiera e la fiamma del gas.

**EN Cast iron teapot 1L.** With its modern design and vibrant colors, it makes your kitchen and table unique. Cast iron provides excellent heat conduction and retains it for several hours. It is recommended to remove the steel filter during boiling and to use a flame diffuser to place between the teapot and the gas flame.

**FR Théière en fonte 1L.** Avec son design moderne et ses couleurs vives, elle rend votre cuisine et votre table originales. La fonte permet une excellente conduction de la chaleur et la conserve pendant plusieurs heures. Il est conseillé de retirer le filtre en acier pendant l'ébullition et d'utiliser un diffuseur de flamme à placer entre la théière et la flamme du gaz.



WD771AR



8 053300 578382



WD771AZ



8 053300 578375



WD771C



8 053300 578368



WD771N



8 053300 578399

16 cm



10,5 cm



No lavastoviglie  
No dishwasher  
Pas de lave-vaisselle



No microonde  
No microwave  
Pas de micro-ondes



Per la cottura sui fornelli si consiglia l'ausilio di uno spargifiamma  
Il est recommandé d'utiliser un diffuseur de flamme pour la cuisson sur la cuisinière  
For cooking on the stove, the use of a flame spreader is recommended



### WD772

**IT French press in ghisa 850 ml.** Dal design moderno e dai colori brillanti, rende la tua cucina e la tua tavola originale. Perfette per una pausa caffè originale.

**EN French press cast iron 850 ml.** With its modern design and vibrant colors, it makes your kitchen and table unique. Perfect for a unique coffee break.

**FR Cafetière à piston en fonte 850 ml.** Avec son design moderne et ses couleurs vives, elle rend votre cuisine et votre table originales. Parfaite pour une pause café unique.



*Con stantuffo*  
*With plunger*  
*Avec piston*

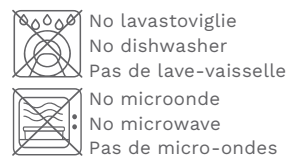

### WD773

**IT Set 2 tazzine ghisa 100 ml.** Dal design moderno e dai colori brillanti, rendono la tua cucina e la tua tavola originale. La ghisa permette di mantenere le tue bevande calde, per poterle gustare al meglio.

**EN Set of 2 cast iron cups 100 ml.** With their modern design and vibrant colors, they make your kitchen and table unique. Cast iron keeps your drinks hot, allowing you to enjoy them to the fullest.

**FR Set de 2 tasses en fonte 100 ml.** Avec leur design moderne et leurs couleurs vives, elles rendent votre cuisine et votre table originales. La fonte permet de maintenir vos boissons chaudes, pour les déguster au mieux.

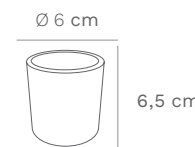

### WD706

**IT** Teiere in ghisa resistenti e raffinate, permettono un'ottima conduzione di calore e lo preservano per diverse ore. Se si usa per bollire l'acqua è consigliabile togliere il filtro durante la bollitura ed usare uno spargi fiamma da interporre tra la teiera e la fiamma del gas.

**EN** Durable and refined cast iron teapots that allow excellent heat conduction and preserve it for several hours. If you use it to boil water, it is advisable to remove the filter while boiling and use a flame spreader to be placed between the teapot and the gas flame.

**FR** Théières en fonte, durables et raffinées, permettent une excellente conduction de la chaleur et la conservent pendant plusieurs heures. Si vous l'utilisez pour faire bouillir de l'eau, il est conseillé de retirer le filtre pendant l'ébullition et d'utiliser un répartiteur de flamme à placer entre la théière et la flamme du gaz.



- No lavastoviglie  
No dishwasher  
Pas de lave-vaisselle
- No microonde  
No microwave  
Pas de micro-ondes

Per la cottura sui fornelli si consiglia l'ausilio di uno spargifiamma  
Il est recommandé d'utiliser un diffuseur de flamme pour la cuisson sur la cuisinière  
For cooking on the stove, the use of a flame spreader is recommended

### WD458

**IT** Teiere in ghisa arricchite da raffinati dettagli color oro che le rendono ancora più uniche e ricercate. Lo spessore uniforme delle teiere in ghisa conferiscono un'ottima conduzione di calore e lo preservano in maniera unica. Se si usa la teiera per bollire l'acqua, è consigliabile rimuovere il filtro durante la bollitura ed usare uno spargifiamma da interporre fra la teiera e la fiamma del gas.

**EN** The homogenous thickness of the cast iron teapots gives excellent heat conduction and preservation. If the pot is used to boil water on the stove, it is recommended to remove the filter and to use a fire net in between your pot and the flame to disperse the direct heat.

**FR** Théière en fonte avec relief doré. L'épaisseur uniforme des théières en fonte permet une excellente conduction de la chaleur et la conserve d'une manière unique. Si vous utilisez la théière pour faire bouillir de l'eau, il est conseillé de retirer le filtre pendant l'ébullition et d'utiliser un diffuseur de flamme entre la théière et la flamme du gaz. Fournie avec un filtre inox. Poignée dorée et inclinable. Intérieur émaillé.



- No lavastoviglie  
No dishwasher  
Pas de lave-vaisselle
- No microonde  
No microwave  
Pas de micro-ondes

Per la cottura sui fornelli si consiglia l'ausilio di uno spargifiamma  
Il est recommandé d'utiliser un diffuseur de flamme pour la cuisson sur la cuisinière  
For cooking on the stove, the use of a flame spreader is recommended

**WD430**

**IT Set teiera con filtro** (800ml) + 4 bicchieri (100ml) in ghisa in colore grigio con texture rossa a rilievo.

**EN Teapot with filter** (800ml) + 4 cups (100ml) in cast iron material in grey colour color with embossed red reliefs.

**FR Ensemble de théière avec filtre** (800ml) + 4 verres (100ml) en fonte grise avec texture en relief rouge.



Per la cottura sui fornelli si consiglia l'ausilio di uno spargifiamma  
*Il est recommandé d'utiliser un diffuseur de flamme pour la cuisson sur la cuisinière*  
 For cooking on the stove, the use of a flame spreader is recommended



No lavastoviglie  
 No dishwasher  
 Pas de lave-vaisselle



No microonde  
 No microwave  
 Pas de micro-ondes



WD430



8 033040 745411

**CARATTERISTICHE:**

La storia della fusione della ghisa in Giappone è antichissima e risale almeno alla fine dell'XI secolo. Questi prodotti tradizionali in ghisa mostrano una bellezza e una maestria degne di trasformare il momento del tè in una vera e propria arte. Lo spessore uniforme delle teiere in ghisa conferisce un'ottima conduzione di calore e lo preserva in maniera unica. Se si usa la teiera per bollire l'acqua, è consigliabile rimuovere il filtro durante la bollitura e usare uno spargifiamma da interporre fra la teiera e la fiamma del gas.

**FEATURES:**

The ancient history of cast iron in Japan dates back to end of the 11th century. These traditional cast iron products show a beauty and a mastery worthy of transforming the tea break into real art. The homogenous thickness of the cast iron teapots gives excellent heat conduction and preservation. If the pot is used to boil water on the stove, it is recommended to remove the filter and to use a fire net in between your pot and the flame to disperse the direct heat.

**CARACTÉRISTIQUES:**

L'histoire de la fonte au Japon est très ancienne et remonte au moins à la fin du XIe siècle. Ces produits traditionnels en fonte affichent une beauté et un savoir-faire dignes de faire de l'heure du thé un véritable art. L'épaisseur uniforme des théières en fonte permet une excellente conduction de la chaleur et la conserve d'une manière unique. Si la théière est utilisée pour faire bouillir de l'eau, il est conseillé d'enlever le filtre pendant l'ébullition et d'utiliser un diffuseur de flamme à placer entre la théière et la flamme du gaz.

**WD431**

**IT Set teiera con filtro** (1000ml) + 4 bicchieri (100ml) in ghisa in colore viola con texture orizzontale a rilievo.

**EN Teapot with filter** (1000ml) + 4 cups (100ml) in cast iron material in purple colour color with embossed red reliefs.

**FR Théière avec filtre** (1000ml) + 4 verres (100ml) en fonte violette avec texture horizontale en relief.



WD431



8 033040 745428



No lavastoviglie  
 No dishwasher  
 Pas de lave-vaisselle



No microonde  
 No microwave  
 Pas de micro-ondes



Per la cottura sui fornelli si consiglia l'ausilio di uno spargifiamma  
*Il est recommandé d'utiliser un diffuseur de flamme pour la cuisson sur la cuisinière*  
 For cooking on the stove, the use of a flame spreader is recommended



### WD432

**IT Set teiera con filtro** (500ml) + 4 bicchieri (50ml) in ghisa in colore blu con texture colore oro a rilievo.

**EN Teapot with filter** (500ml) + 4 cups (50ml) in cast iron material in blue colour with embossed gold reliefs.

**FR Ensemble de théière avec filtre** (500ml) + 4 verres (50ml) en fonte de couleur bleue avec texture en relief dorée.



Per la cottura sui fornelli si consiglia l'ausilio di uno spargifiamma  
*Il est recommandé d'utiliser un diffuseur de flamme pour la cuisson sur la cuisinière*  
For cooking on the stove, the use of a flame spreader is recommended

### WD433

**IT Set teiera con filtro** (600ml) + 4 bicchieri (50ml) in ghisa in colore rosso con texture a rilievo.

**EN Teapot with filter** (600ml) + 4 cups (50ml) in cast iron material in red colour with embossed reliefs.

**FR Ensemble de théière avec filtre** (600ml) + 4 verres (50ml) en fonte de couleur rouge avec texture en relief.

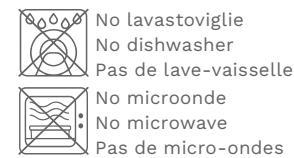

Per la cottura sui fornelli si consiglia l'ausilio di uno spargifiamma  
*Il est recommandé d'utiliser un diffuseur de flamme pour la cuisson sur la cuisinière*  
For cooking on the stove, the use of a flame spreader is recommended

# HABANA LINE

## WD714

**IT Set 18 piatti bicolore in stoneware.** La finitura opaca e l'aspetto naturale alla base si adattano ad una varietà di stili diversi da quelli più moderni a quelli più rustici. Perfetto per apparecchiare la tavola con originalità ed eleganza.

**EN Set of 18 two-tone stoneware plates.** The matte finish and natural look at the base fit a variety of different styles, from modern to more rustic. Perfect for setting the table with originality and elegance.

**FR Set de 18 assiettes bicolores en stoneware.** La finition opaque et l'aspect naturel à la base conviennent à une variété de styles différents, des plus modernes aux plus rustiques. Parfait pour mettre la table avec originalité et élégance.



WD714B



8 053300 575909



WD714BL



8 053300 575893



Ø 26,5 cm

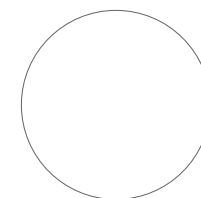

Ø 20 cm

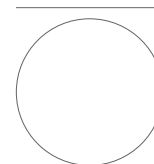

Ø 18,5 cm

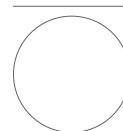

WD714G



8 053300 575916



## WD643

**IT Set 4 coppette gelato con paletta in porcellana New Bone Cina.** Coppette arricchite da aforismi che richiamano il gelato. Capacità: 250ml.

**EN Set of 4 New Bone China ice cups with spoon.** Ice cups enriched with aphorisms that recall the ice cream. Capacity: 250ml.

**FR Set 4 bols pour la glace avec palette en porcelaine New Bone China.** Bols enrichis d'aphorismes rappelant la glace. Contenance: 250ml.



WD643  
8 053300 573158

Ø 8,5 cm



7 cm

-  Si lavastoviglie  
Dishwasher safe  
Lave-vaisselle possible
-  Si microonde  
Microwave safe  
Micro-ondes possible



### WD638

**IT Set 6 tazzine da caffè in New Bone China.** Coloratissime e arricchite da aforismi che ti faranno iniziare la giornata con il piede giusto. Capacità: 100ml.

**EN Set of 6 coffee cups in New Bone China.** Colorful and enriched with aphorisms that will make you start the day on the right foot. Capacity: 100ml.

**FR Set de 6 tasses à café en New Bone China.** Colorées et enrichies d'aphorismes qui vous permettront de commencer votre journée du bon pied. Capacité: 100ml.



WD638  
8 053300 573011

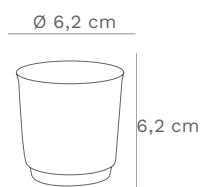

-  Si lavastoviglie  
Dishwasher safe  
Lave-vaisselle possible
-  Si microonde  
Microwave safe  
Micro-ondes possible

### WD639

**IT Set 4 tazze in New Bone China.** Coloratissime e arricchite da aforismi che ti faranno iniziare la giornata con il piede giusto. Capacità: 350ml.

**EN Set of 4 mugs in New Bone China.** Colorful and enriched with aphorisms that will make you start the day on the right foot. Capacity: 350ml.

**FR Set de 4 tasses en New Bone China.** Colorées et enrichies d'aphorismes pour commencer votre journée du bon pied. Capacité: 350ml.



WD639  
8 053300 573028

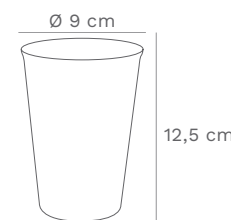

-  Si lavastoviglie  
Dishwasher safe  
Lave-vaisselle possible
-  Si microonde  
Microwave safe  
Micro-ondes possible



# ISTANBUL LINE



## WD681

**IT Poggia mestolo in ceramica decorato a mano.** È il regalo perfetto per donare un tocco di stile e di personalità alla cucina e rappresenta una soluzione pratica per mantenere pulita la zona di lavoro, proteggendo le superfici da gocce o macchie.

**EN Hand-decorated ceramic ladle holder.** Is the perfect gift to add a touch of style and personality to the kitchen and is a practical solution for keeping the cooking area clean, protecting surfaces from drips or stains.

**FR Porte-louche en céramique décoré à la main.** Est le cadeau idéal pour ajouter une touche de style et de personnalité à la cuisine. Il s'agit d'une solution pratique pour garder la zone de travail propre, en protégeant les surfaces contre les gouttes ou les taches.



WD681BL



8 053300 574674



WD681GI



8 053300 574698



WD681N



8 053300 574704



WD681R



8 053300 574681



WD681T



8 053300 574711



WD681V



8 053300 574728

11 cm



22,5 cm



Si lavastoviglie  
Dishwasher safe  
Lave-vaisselle possible

MADE IN  
TURKEY

*Dipinto  
a mano  
Hand  
painted  
Peint à  
la main*



### WD671

**IT Set di 2 piatti da dessert.** Lavorati e decorati interamente a mano, per regalare alla tua tavola un tocco di vivacità.

**EN Set of 2 dessert plates** crafted and decorated entirely by hand to give your table a lively touch.

**FR Set de 2 assiettes à dessert** fabriquées et décorées entièrement à la main, pour donner à votre table une touche de vivacité.

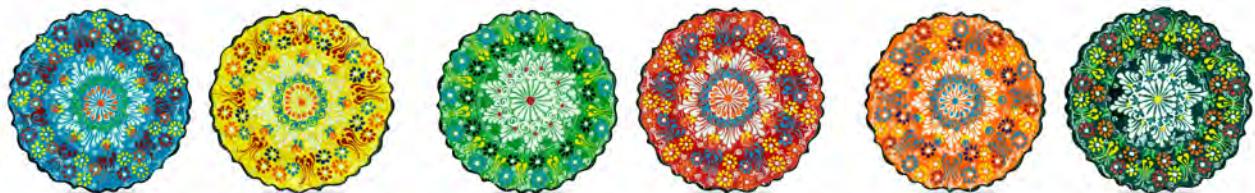

WD671GIAZ



8° 053300° 574230

WD671RME



8° 053300° 574247

WD671VAR



8° 053300° 574254

18 cm

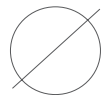

Si lavastoviglie  
Dishwasher safe  
Lave-vaisselle possible



Si microonde  
Microwave safe  
Micro-ondes possible



### WD672

**IT Set di 2 piatti ovali.** Lavorati e decorati interamente a mano, per dare ai tuoi aperitivi un tocco orientale grazie ai colori vivaci e ai decori in rilievo.

**EN Set of 2 oval plates** crafted and decorated entirely by hand, to give your appetizers an oriental touch thanks to the bright colors and embossed decorations.

**FR Set de 2 assiettes ovales** entièrement fabriquées et décorées à la main, pour donner à vos apéritifs une touche orientale grâce aux couleurs vives et aux décorations en relief.

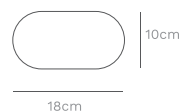

18cm

10cm



28cm

14cm



Si lavastoviglie  
Dishwasher safe  
Lave-vaisselle possible



Si microonde  
Microwave safe  
Micro-ondes possible

WD672GIV



8° 053300° 574278

WD672RAZ



8° 053300° 574261

### WD673

**IT Brocca lavorata e decorate a mano.** Per portare in tavola la vivacità e lo stile dei colori orientali. Capacità 1,5L.

**EN Pitcher, handcrafted and hand-decorated** to bring the vibrancy and style of oriental colors to the table. 1,5L. capacity.

**FR Carafe fabriquée et décorée à la main** pour apporter à la table la vivacité et le style des couleurs orientales. Capacité de 1,5L.



WD673BL



8° 053300° 574292

WD673R



8° 053300° 574285

12 cm



19,5 cm



Si lavastoviglie  
Dishwasher safe  
Lave-vaisselle possible



Si microonde  
Microwave safe  
Micro-ondes possible

MADE IN  
TURKEY

*Dipinto  
a mano  
Hand  
painted  
Peint à  
la main*





**WD622**

**IT** Ciotola-Insalatiera in ceramica. Lavorata e decorata interamente a mano con colori vibranti e decori a rilievo.

**EN** Bowl in ceramic entirely worked and decorated by hand with vibrant colors and relief decorations.

**FR** Bol-saladier en céramique travaillé et décoré entièrement à la main avec des couleurs vibrantes et des décorations en relief.

**MADE IN  
TURKEY**

*Dipinto  
a mano  
Hand  
painted  
Peint à  
la main*



WD622AR



8 053300 571994



WD622AZ



8 053300 571970



WD622R



8 053300 573035



WD622V



8 053300 573042



Si lavastoviglie  
Dishwasher safe  
Lave-vaisselle possible

Si microonde  
Microwave safe  
Micro-ondes possible

### WD621

**IT Set 3 coppette** lavorate e decorate interamente a mano con colori vibranti e decori a rilievo.

**EN Set of 3 cups** entirely worked and decorated by hand with vibrant colors and relief decorations.

**FR Ensemble de 3 petits bols**, entièrement réalisés et décorés à la main avec des couleurs vives et des décorations en relief.



**MADE IN  
TURKEY**

*Dipinto  
a mano  
Hand  
painted  
Peint à  
la main*

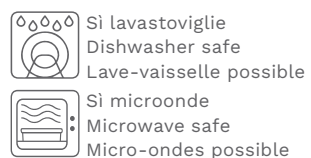

### WD623

**IT Mug** lavorate e decorate interamente a mano con colori vibranti e decori a rilievo.

**EN Mugs** entirely worked and decorated by hand with vibrant colors and relief decorations.

**FR Mug** en céramique en boîte cadeau. Entièrement fabriqué et décoré à la main avec des couleurs vives et une décoration en relief.



### WD438

**IT Set 6 coppette in ceramica** multiuso, lavorate a mano interamente e decorate con colori a rilievo. Capacità: 280ml.

**EN Set of 6 hand-made ceramic** cups entirely decorated with embossed colors. Capacity: 280ml.

**FR Set de 6 Coupelles en céramique** en boîte cadeau entièrement réalisées à la main et décorées de couleurs en relief. Contenance: 280ml.

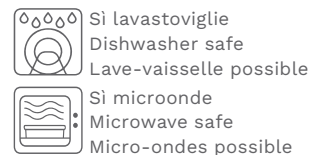

**MADE IN  
TURKEY**

*Dipinto Hand  
Painted la main*



**WD495**

**IT Sottopentola in ceramica** lavorato e decorato interamente a mano che regala vivacità alla tua tavola grazie ai colori vibranti ed ai decori a rilievo.

**EN Ceramic trivet** entirely made and decorated by hand with vibrant colors and embossed decorations giving a happy atmosphere to your table.

**FR Dessous-de-plat en céramique** fabriqué et décoré à la main qui apporte de l'éclat à votre table grâce à ses couleurs vives et ses décorations en relief.



WD495AR  
8 033040 747071



WD495AZ  
8 033040 747088



WD495BL  
8 053300 570638



WD495GI  
8 053300 570645



WD495ME  
8 053300 570652



WD495R  
8 033040 747101



WD495RA  
8 053300 570669



WD495V  
8 033040 747125

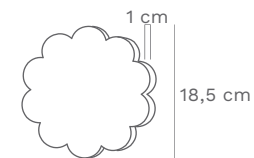

No lavastoviglie  
No dishwasher  
Pas de lave-vaisselle  
No microonde  
No microwave  
Pas de micro-ondes

**MADE IN TURKEY** *Dipinto Hand Paint à mano painted la main*



# INDICE ARTICOLI | ARTICLES INDEX | INDEX DES ARTICLES:

WD018B	245	WD365LIME	115	WD407TR	236	WD506CAL	113	WD566COC	143	WD566PRA	137
WD018BEI	245	WD365MAGENTA	115	WD407V	236	WD506CO	113	WD566COL	150	WD566PTO	137
WD018BLACK	245	WD365MAIO	117	WD408AM	237	WD506LET	113	WD566CONI	143	WD566QUA	145
WD018BLU	245	WD365MANDALA	117	WD408AVI	237	WD506ME	113	WD566COR	140	WD566RAN	144
WD018BOR	245	WD365MANDARINO	115	WD408BL	237	WD506SQU	113	WD566CUO	152	WD566RIN	142
WD018DAB	244	WD365MESSICO	117	WD408GOLD	240	WD518	124	WD566DEL	140	WD566ROS	141
WD018DAG	244	WD365N	115	WD408M	237	WD523N	258	WD566ELE	143	WD566SAC	145
WD018DAM	244	WD365NOTTE	115	WD408R	237	WD523R	258	WD566FAR	143	WD566SCA	152
WD018FOG	244	WD365PAN	120	WD408T	237	WD523S	258	WD566FEN	143	WD566SCI	142
WD018GOLD	245	WD365PAP	117	WD408TR	237	WD537B	272	WD566FRA	151	WD566SIA	147
WD018KAS	244	WD365PAVONE	117	WD408V	237	WD537CA	271	WD566FUN	143	WD566SQU	140
WD018MAIO	244	WD365PES	117	WD424	255	WD537G	272	WD566GAB	143	WD566STE	140
WD018PET	244	WD365PETROLIO	116	WD430	313	WD537MAT	271	WD566GAL	144	WD566TAR	144
WD018RED	245	WD365R	116	WD431	314	WD537N	272	WD566GAT	147	WD566TON	139
WD018SILVER	245	WD365RO	116	WD432	315	WD537PA	271	WD566GEC	142	WD566TOR	149
WD018VIN	244	WD365SA	116	WD433	316	WD537PET	272	WD566GIR	144	WD566TUC	142
WD173	190	WD365SILVER	116	WD438	330	WD537SEN	271	WD566GRA	140	WD566TUL	144
WD174	190	WD365TAT	117	WD440T	246	WD550	124	WD566GUF	144	WD566UVA	144
WD318	190	WD365V	116	WD458AZ	312	WD564ALB	171	WD566KOA	142	WD566VOL	144
WD319	190	WD405AM	234	WD458B	312	WD564ARA	156	WD566LIM	151	WD566ZUC	144
WD365APE	117	WD405AVI	234	WD458BL	312	WD564BAL	156	WD566LUC	152	WD569	126
WD365AR	115	WD405BL	234	WD458F	312	WD564FEN	155	WD566MAI	149	WD571BE	262
WD365ARA	117	WD405GOLD	240	WD474B	121	WD564PUP	171	WD566MAN	145	WD571BL	262
WD365AZ	115	WD405M	234	WD474BL	121	WD564QUA	156	WD566MAR	144	WD571DECG	263
WD365B	115	WD405R	234	WD474G	121	WD564SOT	156	WD566MED	140	WD571DECO	263
WD365BA	115	WD405T	234	WD474GI	121	WD565CIL	154	WD566MEL	151	WD571DECR	263
WD365BEA	117	WD405TR	234	WD474MAT	121	WD565CUO	154	WD566MUC	149	WD571DECV	263
WD365BL	115	WD405V	234	WD474N	121	WD565NIN	154	WD566NAT	178	WD571G	262
WD365CAN2	120	WD406AM	235	WD474OL	121	WD565PAN	170	WD566NAT3	178	WD571N	262
WD365CE	115	WD406AVI	235	WD474PET	121	WD565PES	154	WD566NAT4	177	WD571R	262
WD365CO	116	WD406BL	235	WD474R	121	WD565STAR	170	WD566ORA	141	WD571V	262
WD365COS	117	WD406GOLD	240	WD480	258	WD566ALL	142	WD566ORO	139	WD572	256
WD365F	116	WD406M	235	WD495AR	332	WD566APE	143	WD566ORR	141	WD573	256
WD365FIO	117	WD406R	235	WD495AZ	332	WD566ARA	151	WD566PAG	139	WD575ANT	122
WD365FRU	117	WD406T	235	WD495BL	332	WD566ASI	149	WD566PAN	142	WD575AZ	122
WD365G	116	WD406TR	235	WD495GI	332	WD566AZZ	139	WD566PAP	144	WD575CO	122
WD365GAT2	120	WD406V	235	WD495ME	332	WD566BAL	139	WD566PAPE	144	WD575LIL	122
WD365GC	116	WD407AM	236	WD495R	332	WD566BAS	147	WD566PEC	142	WD575TER	122
WD365GI	116	WD407AVI	236	WD495RA	332	WD566BLU	141	WD566PEL	142	WD575V	122
WD365GIR	117	WD407BL	236	WD495V	332	WD566BOR	152	WD566PEP	145	WD577B	265
WD365JUNGLE	117	WD407GOLD	240	WD496	287	WD566CAN	147	WD566PFA	137	WD577C	265
WD365KIT	123	WD407M	236	WD498	286	WD566CAR	139	WD566PFU	137	WD577F	265
WD365KOA	120	WD407R	236	WD506AR	113	WD566CAV	140	WD566PIN	143	WD577T	265
WD365LILLA	116	WD407T	236	WD506BL	113	WD566CIG	150	WD566POL	140	WD579	254

WD581	276	WD624V	181	WD652G	209	WD689LI	45	WD707A	300	WD721RAN	74
WD585ANC	153	WD625BL	183	WD653	210	WD689PE	45	WD707B	300	WD721TAR	74
WD585ANG	153	WD625GI	183	WD654	211	WD689R	45	WD707C	300	WD722A	33
WD585FOC	153	WD625V	183	WD655AM	212	WD689TR	45	WD707D	300	WD722B	33
WD585ORO	153	WD626BL	182	WD655BL	209	WD690LI	46	WD708B	280	WD722C	33
WD585SCH	172	WD626GI	182	WD655BL	212	WD690R	46	WD708N	280	WD722D	33
WD586	266	WD626V	182	WD655GI	212	WD690TR	46	WD709BL	158	WD725AN	99
WD587	249	WD627BL	186	WD658AR	282	WD690V	46	WD709G	158	WD725AR	99
WD588	250	WD627GI	186	WD658AZ	282	WD691FEN	79	WD709V	158	WD725AZ	99
WD589	251	WD627V	186	WD658BL	282	WD691PAPPA	80	WD710COC	167	WD725BL	99
WD591	259	WD632	187	WD658GI	282	WD691PAV	80	WD710CUO	167	WD725CR	99
WD592	260	WD633ALB	174	WD659AR	283	WD692CIG	81	WD710FAR	167	WD725RO	99
WD593	259	WD633BIS	160	WD659AZ	283	WD692PAP	81	WD710FIO	179	WD725SEN	99
WD594	260	WD633BRI	160	WD659R	283	WD692TAR	79	WD710GHI	179	WD725V	99
WD596B	198	WD633CAN	161	WD659VE	283	WD693CAN	82	WD711AN	39	WD726AR	90
WD596V	198	WD633CER	161	WD660AVI	269	WD693OLI	79	WD711CR	39	WD726BL	90
WD597	197	WD633CUP	160	WD660B	269	WD693PAG	82	WD711R	39	WD726GI	90
WD598	196	WD633GAT	161	WD660MEL	269	WD694FAR	79	WD711V	39	WD726OL	90
WD599GI	199	WD633GHI	174	WD660N	269	WD694FEN	83	WD714B	318	WD726R	90
WD599V	199	WD633MAC	160	WD660TOR	269	WD694GAL	83	WD714BL	318	WD726RO	90
WD600	200	WD633PAN	174	WD671GIAZ	325	WD695AZZ	136	WD714G	318	WD726V	90
WD601B	200	WD633SCH	174	WD671RME	325	WD695NAT1	176	WD716APE	135	WD727BL	94
WD602	200	WD633SCO	161	WD671VAR	325	WD695NAT2	176	WD716CON	135	WD727GI	94
WD603	194	WD633TOR	160	WD672GIV	325	WD695NAT3	175	WD717APE	133	WD728BL	95
WD604	195	WD635HAP	214	WD672RAZ	325	WD695ROS	136	WD717COC	133	WD728GI	95
WD605	193	WD636CAC	168	WD673BL	326	WD698	291	WD717FAR	133	WD729BL	96
WD606	192	WD636CAM	168	WD673R	326	WD699	292	WD717LIB	133	WD729GI	96
WD607	253	WD636GIR	168	WD674	238	WD700A	293	WD717LUM	133	WD730	102
WD609	301	WD637	248	WD674	238	WD700B	293	WD717MAR	133	WD730	102
WD610	302	WD638	321	WD680	216	WD700C	293	WD718B	35	WD731	103
WD611	303	WD639	322	WD681BL	324	WD700O	293	WD718BL	35	WD732	104
WD612BL	304	WD641	274	WD681GI	324	WD701A	294	WD718R	35	WD733	105
WD612V	304	WD643	319	WD681N	324	WD701B	294	WD718RO	35	WD734	108
WD613AZ	306	WD644OLI	165	WD681R	324	WD701C	294	WD718V	35	WD736AR	218
WD613F	306	WD645ACE	164	WD681T	324	WD702A	296	WD719B	36	WD737BO	218
WD615	191	WD645PEP	166	WD681V	324	WD702B	296	WD719R	36	WD737PER	228
WD621	329	WD646RO	205	WD686CE	41	WD702C	296	WD719RO	36	WD738LI	218
WD622AR	328	WD647AZ	205	WD686GI	41	WD703A	297	WD719V	36	WD738ORO	229
WD622AZ	328	WD648AR	205	WD686R	41	WD703B	297	WD720CHE	60	WD739AR	219
WD622R	328	WD649AR	203	WD686TR	41	WD703C	297	WD720DRE	60	WD739BO	219
WD622V	328	WD649AZ	203	WD687PET	42	WD703D	297	WD720HAP	60	WD739LI	219
WD623BL	329	WD649G	203	WD687R	42	WD704A	298	WD720HOM	60	WD740BO	221
WD623GI	329	WD649PE	203	WD687RO	42	WD704B	298	WD720LOV	60	WD740T	221
WD623R	329	WD650V	206	WD687TR	42	WD705	299	WD720REL	60	WD740V	221
WD623V	329	WD651	208	WD688BL	43	WD706AN	311	WD721ALL	74	WD741AR	222
WD624BL	181	WD652AM	209	WD688R	43	WD706B	311	WD721ARA	74	WD741BO	222
WD624GI	181	WD652B	209	WD688TR	43	WD706G	311	WD721DEL	74	WD741LI	222
				WD688V	43	WD706V	311	WD721POL	74	WD742AR	223

WD742BO	223	WD760ROS	64	WD778BIS	132	WD798	101	WD813BIE	73
WD742LI	223	WD761AR	56	WD779CAF	132	WD799BL	92	WD813CAR	73
WD742ORO	231	WD761AZ	56	WD780BL	26	WD799GI	92	WD813CAV	73
WD743AR	224	WD761G	56	WD780V	26	WD799OL	92	WD813OLI	73
WD743LI	224	WD761PE	56	WD781BL	27	WD799R	92	WD813ROS	73
WD743T	224	WD761R	56	WD781V	27	WD799RO	92	WD814AGL	71
WD744AR	226	WD761VI	56	WD782B	28	WD800BL	91	WD814BIE	71
WD744BO	226	WD762	57	WD782BL	28	WD800OL	91	WD814CAR	71
WD744LI	226	WD763A	58	WD782V	28	WD800R	91	WD814CAV	71
WD749ORO	232	WD764A	58	WD783BL	30	WD800RO	91	WD814OLI	71
WD749PER	232	WD765A	58	WD783V	30	WD801AR	112	WD814ROS	71
WD751R	48	WD766BL	204	WD784CON	70	WD801BL	112	WD815A	72
WD751TR	48	WD766RO	204	WD784FAR	70	WD801CA	112	WD815B	72
WD751V	48	WD767AR	38	WD784FEN	70	WD801V	112	WD816AR	53
WD752G	202	WD767B	38	WD784OLI	70	WD802CUO	18	WD816BL	53
WD753V	202	WD767BL	38	WD784PAG	70	WD802FIO	18	WD817AR	54
WD754AM	202	WD767N	38	WD784TAR	70	WD802NUV	18	WD817AZ	54
WD755ARA	78	WD768B	242	WD785CES	61	WD802OBL	18	WD818AR	52
WD755CAN	78	WD768BE	242	WD785DRA	61	WD802ORI	18	WD818RO	52
WD755COR	86	WD768N	242	WD786PEA	62	WD802SCA	18	WD819A	50
WD755FEN	78	WD768R	242	WD786YOU	62	WD803AZ	4	WD819B	50
WD755PAN	86	WD769B	278	WD789	290	WD803CR	4	WD820A	31
WD755PAP	78	WD769CA	278	WD790GI	21	WD804CAV	5	WD821AZ	110
WD755POL	78	WD769N	278	WD790N	21	WD804GRA	5	WD821B	110
WD755TAR	78	WD769PET	278	WD790RO	21	WD804PES	5	WD821CO	110
WD756COR	87	WD770AR	268	WD790V	21	WD804POL	5	WD821G	110
WD756PAN	87	WD770B	268	WD791AR	20	WD805AZ	6	WD821LI	110
WD757CAS	75	WD770BL	268	WD791GI	20	WD805CR	6	WD821OL	110
WD757FAR	75	WD770N	268	WD791RO	20	WD806ARA	7		
WD757OLI	75	WD771AR	308	WD791V	20	WD806GRA	7		
WD757PAL	75	WD771AZ	308	WD792AR	23	WD806POL	7		
WD757POL	75	WD771C	308	WD792AZ	23	WD806STE	7		
WD757RAC	75	WD771N	308	WD792GI	23	WD807ARA	8		
WD758CON	79	WD772AR	309	WD792V	23	WD807STE	8		
WD758COR	85	WD772AZ	309	WD793	24	WD808ARA	10		
WD758MAC	84	WD772C	309	WD795CUO	15	WD808GRA	10		
WD758PAN	85	WD772N	309	WD795FIO	15	WD808POL	10		
WD758UOV	84	WD773AR	310	WD795NUV	15	WD808STE	10		
WD759AVI	68	WD773AZ	310	WD795OBL	15	WD809CAV	11		
WD759B	68	WD773C	310	WD795ORI	15	WD809POL	11		
WD759G	68	WD773N	310	WD795SCA	15	WD810ARA	12		
WD759N	68	WD775CAN	128	WD796FIO	14	WD811STE	12		
WD759R	68	WD775DEL	128	WD796NUV	14	WD812G	98		
WD759V	68	WD775GAT	128	WD796OBL	14	WD812MA	98		
WD760ARA	65	WD775POL	128	WD796ORI	14	WD812OL	98		
WD760CUO	65	WD776	129	WD797OBL	17	WD812SA	98		
WD760NUV	64	WD777CAR	132	WD797ORI	17	WD813AGL	73		

## INDICE LINEE | LINE INDEX | INDICE DES LIGNE:

<b>BREST LINE.....</b>	<b>3</b>
<b>GUATAPÈ LINE .....</b>	<b>13</b>
<b>SINTRA LINE .....</b>	<b>19</b>
<b>SAMARCANDA LINE .....</b>	<b>25</b>
<b>ANVERSA LINE.....</b>	<b>49</b>
<b>TOKYO LINE .....</b>	<b>59</b>
<b>FREIBURG LINE.....</b>	<b>67</b>
<b>MYKONOS LINE .....</b>	<b>69</b>
<b>AUSTIN LINE .....</b>	<b>89</b>
<b>MIAMI LINE .....</b>	<b>109</b>
<b>MONTEREY LINE .....</b>	<b>127</b>
<b>OLIMPIA LINE.....</b>	<b>201</b>
<b>ACAPULCO LINE .....</b>	<b>213</b>
<b>BALAT LINE.....</b>	<b>217</b>
<b>NEW YORK LINE .....</b>	<b>233</b>
<b>NAPA LINE.....</b>	<b>241</b>
<b>ROMA LINE.....</b>	<b>247</b>
<b>SIENA LINE.....</b>	<b>261</b>
<b>MILANO LINE .....</b>	<b>267</b>
<b>HONG KONG LINE.....</b>	<b>281</b>
<b>KAFFA LINE.....</b>	<b>285</b>
<b>PECHINO LINE .....</b>	<b>289</b>
<b>OSAKA LINE .....</b>	<b>307</b>
<b>HABANA LINE .....</b>	<b>317</b>
<b>ISTANBUL LINE.....</b>	<b>323</b>